

# Installation, maintenance, assembly and operating manual for minimum flow valves of type SUL



BA-SUL-01-EN

Version: 05.2017

## Content

|          |   |           |
|----------|---|-----------|
| <b>1</b> | <b>General</b>  | <b>4</b>  |
| 1.1      | Customer service and procedure when servicing               | 4         |
| 1.2      | About this manual   | 4         |
| 1.3      | Applicability of this operating manual                      | 5         |
| 1.3.1    | Applicable documents  | 5         |
| 1.4      | Subject to change   | 5         |
| 1.5      | Warranty/guarantee  | 5         |
| <b>2</b> | <b>Explanation of symbols and safety instructions</b>       | <b>6</b>  |
| 2.1      | Explanation of symbols                                      | 6         |
| 2.2      | Notes on dangers and warnings                               | 7         |
| 2.3      | Safety instructions   | 8         |
| <b>3</b> | <b>Packing</b>  | <b>9</b>  |
| <b>4</b> | <b>Transport and storage</b>                                | <b>10</b> |
| <b>5</b> | <b>Description and technical data</b>                       | <b>11</b> |
| 5.1      | Intended Use  | 11        |
| 5.2      | Structure of the valve type SUL                             | 12        |
| 5.2.1    | Valve type SUL without non-return function                  | 12        |
| 5.2.2    | Valve type SUL with non-return function                     | 13        |
| 5.3      | Functioning of the valve type SUL                           | 14        |
| 5.4      | General notes regarding operation of the valve              | 16        |
| 5.5      | Normal operational requirement                              | 17        |
| 5.6      | Identification of the valve                                 | 18        |
| <b>6</b> | <b>Installation of the valve in the plant</b>               | <b>19</b> |
| 6.1      | Please observe before the installation in the pipeline!     | 19        |
| 6.2      | Installation of the valve                                   | 23        |
| 6.2.1    | Valve with flanges  | 23        |
| 6.2.2    | Valve with welding ends                                     | 23        |
| <b>7</b> | <b>Pickling and flushing</b>                                | <b>23</b> |
| <b>8</b> | <b>Disassembly</b>  | <b>24</b> |
| 8.1      | Valves with flanges   | 24        |
| 8.2      | Valves with welding ends                                    | 24        |
| <b>9</b> | <b>Disassembly and assembly of the valve and the bypass</b> | <b>25</b> |
| 9.1      | General assembly and disassembly information                | 25        |
| 9.2      | Disassembly and inspection of the SUL valve                 | 27        |

|                 |   |           |
|-----------------|---|-----------|
| 9.3             | Assembly of the valve type SUL .....                      | 29        |
| 9.4             | Mounting torque in Nm for hexagon bolts (item 26) .....   | 30        |
| <b>10</b>       | <b>Commissioning .....</b>                                | <b>31</b> |
| <b>11</b>       | <b>Maintenance .....</b>                                  | <b>32</b> |
| <b>12</b>       | <b>Inspections and inspection schedules .....</b>         | <b>33</b> |
| 12.1            | Inspections .....   | 33        |
| 12.2            | Inspection schedules.....                                 | 33        |
| <b>13</b>       | <b>Causes and remedies in the event of failures .....</b> | <b>34</b> |
| <b>Appendix</b> | <b>.....</b>  | <b>39</b> |
| A.1             | Form for the malfunction .....                            | 39        |

## 1 General

### 1.1 Customer service and procedure when servicing

**Please contact for additional information:**

**SCHROEDAHL GmbH**

Alte Schoenenbacher Str. 4  
51580 Reichshof-Mittelagger

Tel.: +49-2265-9927-0

Fax: +49-2265-9927-927

E-Mail: [schroedahl@circor.com](mailto:schroedahl@circor.com)

Internet: <http://www.schroedahl.de>

**In the event of malfunctions, please fill out the form attached in the Annex and send to the following contact person of SCHROEDAHL:**

**SCHROEDAHL GmbH**

**-After Sales Service-**

Alte Schoenenbacher Str. 4  
51580 Reichshof-Mittelagger

Tel.: +49-2265-9927-0

Fax: +49-2265-9927-927

E-Mail: [schroedahl\\_service@circor.com](mailto:schroedahl_service@circor.com)

Internet: <http://www.schroedahl.de>



INFORMATION

Information regarding the technical data of the valve can be found on the nameplate (see Chapter 5.6 Identification of the valve).

### 1.2 About this manual

General:

This manual applies to installation, maintenance, assembly and operation, unless otherwise agreed. Please refer to the conditions agreed in the purchase order in this connection.

The manual contains basic instructions to be followed for transportation, storage, assembly, commissioning, operation, maintenance and repair. This manual is therefore mandatorily to be read before transportation, storage, installation, commissioning, operation, maintenance and repair by the qualified personnel as well as the assigned operator and must be available at the place of operation.

Also please note in particular the rules and the operating instructions given together with the danger, warning and information symbols. Your non-compliance can lead to damage to the valve as well as slight and heavy injury to persons. If any questions arise after reading through the manual, then please contact the manufacturer or the associated local Sales personnel.

### 1.3 Applicability of this operating manual

This manual applies to valves of the series given on the cover sheet. The conformity of the above type designations with the nameplate of the valve should be ensured before beginning any action and spare part order.

The rules, guidelines and notes given in this operating manual apply to delivery to the EU. Operators outside the EC, in their sole responsibility, must consider the listed rules as a basis for safe handling and assess their implementation against the rules applicable for the erection site.

#### 1.3.1 Applicable documents

This operating manual always includes the standard documents of the valve, such as:

- Data sheet
- Sectional drawing
- Parts list
- Dimension sheet

These order-related documents are supplied along with each purchase order.

### 1.4 Subject to change

The rules, guidelines and notes mentioned in this operating manual correspond to the status of information at the time of the order and are not subject to amendment service. The operator is responsible and obliged to apply them in their latest and valid versions. In principle, the product suitability for a new version cannot be hereby derived.

### 1.5 Warranty/guarantee



The scope and period of a warranty have been specified especially in the "General Terms and Conditions of Sale" or in the contract. The latest version, applicable at the time of delivery, is valid. The details given in this manual are used only to specify the products, and no properties are assured.

Unless special conditions have been agreed upon in the order, our warranty is for 1 year, but limited to 24 months after shipment outside EU.

The manufacturer accepts no liability for, or the warranty excludes, damages or breakdowns due to:

- Non-compliance with this installation, maintenance, assembly and operating manual.
- Damages that have obviously occurred during commissioning due to pollution or unusual operating manner.
- The pressure reduction units and seals subject to wear.
- Unsuitable or improper application as well as during unintended use.
- Faulty assembly, maintenance, incorrect commissioning or to improper operation.
- System-related vibrations of the plant that can arise under certain conditions during pump switching operations, quick shut-off etc.
- Improper operating manner (deviating from the operating data in the data sheet).
- Incorrect or careless handling of the valve.
- Damages caused by components that do not belong to the valve itself.
- Contaminations in the medium (if different from the planned operating conditions).
- Use by inadequately qualified assembly, operating and/or maintenance personnel.
- Unauthorised reworks.
- Changes or reworks on the valve, which are improper or carried out without the prior approval of the manufacturer.

- Use of unapproved spare parts and accessories.

|   |   |
|---|---|
| <br>NOTE | The trim parts and seals of the valve are considered as wear parts.                     |
| <br>NOTE | Our warranty covers only the return and the replacement of faulty material or products. |

## 2 Explanation of symbols and safety instructions





This installation, maintenance, assembly and operating manual specifically focuses on dangers, risks and safety-relevant details by means of an emphatic display.

Notes on dangers and warnings in the text describe rules of conduct, whose non-compliance can lead to serious injuries or death of users or third parties or to property damage of the plant or the environment. They should be followed without fail and marked with a warning triangle.









However, the observance of notes and details is equally indispensable to avoid breakdowns that can directly or indirectly cause damages to personnel or property.

The following dangers, warnings and notes do not take into account any additional regional, local or company-specific safety regulations and it is the responsibility of the operator himself to add them.









### 2.1 Explanation of symbols

|  |  |
|--|--|
| <br>DANGER      | Death, serious bodily injury or substantial property damage will occur, if the relevant precautions are not taken.     |
| <br>WARNING     | There is a threat of property damages or harmful environmental influences in the event of non-compliance with warning. |
| <br>NOTE        | Is a reference to a possible advantage in the case of compliance with the recommendation.                              |
| <br>INFORMATION | Gives useful tips and suggestions.   |

## 2.2 Notes on dangers and warnings

|  |   |
|--|---|
| <br>DANGER    | <p>The valve is under pressure and usually at high temperature during operation.</p> <p><b>Non-compliance can result in death, serious bodily injuries or substantial property damages.</b></p>   |
| <br>DANGER    | <p>The valve can also still contain the medium in a pressure-free condition. Protection measures should be taken from the safety data sheets of the manufacturer of the medium.</p> <p><b>Warning: Serious injuries possible!</b></p> <p>Suitable protective clothing is required for assembly and maintenance work.</p>  |
| <br>DANGER    | <p>As for their danger potential, valves should be treated equivalent to pressure containers. Therefore, the standards, guidelines, accident-prevention regulations, reliability regulation, plant-specific safety regulations corresponding to planning, installation, operation, testing, assembly and maintenance, the relevant site regulations and the technical documents concerning the valve must be followed. Amended requirements or additions are also applicable at the time of installation and must be complied with.</p>   |
| <br>DANGER  | <p>The valves should only be operated within their limits of design and layout. These limits should be taken from the nameplate. They should be operated only within their specified performance limits (see technical data). In particular, the values for the pressure rating, the design pressure, the design temperature and test pressure must not be exceeded, since it may otherwise lead to overloading of the valve.</p> <p>Only those media must be used, against which the materials are resistant and whose application has been planned for this. Dirty media or applications of the valve outside the specified values can lead to component damages.</p> |
| <br>DANGER  | <p>Assembly and maintenance work can only be carried out when the plant has been shut off and the valve is without pressure and has cooled down. Please also follow the plant-specific guidelines.</p>  |
| <br>DANGER  | <p>During the operation, any contact with the valve should be avoided.</p>  |
| <br>WARNING | <p>Do not mount or operate the valve and do not carry out any adjustments on it, if the valve or the supply lines have been damaged.</p>  |
| <br>WARNING | <p>The plant should be commissioned again only after completion of the installation and maintenance work.</p>   |

## 2.3 Safety instructions

|   |   |
|---|---|
| <br>NOTE   | <p>Prerequisite for the installation, operation and maintenance of this valve is the engagement of qualified personnel. It concerns the personnel who are familiar with the installation, commissioning, operation and maintenance of the valve because of their technical training and experience. During the guarantee period, these works must be carried out by SCHROEDAHL personnel or by the plant personnel with a report to SCHROEDAHL. The operator has the responsibility for it and monitoring of personnel must be done by him. If the operator does not possess the required specialised knowledge, then a specialist company should be engaged. Any person entrusted with one of the measures described in this operating manual must have read and understood this manual.</p> |
| <br>NOTE   | <p>Use appropriate tools and devices for installation, maintenance and assembly.</p> <p>Use of spare parts should correspond to the parts list given in the order. These should be procured exclusively from SCHROEDAHL or from our authorised dealers.</p> <p>After completion of the installation, maintenance or repair, test the correct function of the valve and check that there is no leakage in the connecting lines.</p>  |
| <br>NOTE  | <p>The valve should be regularly subjected to a safety check in accordance with the company-specific safety regulations and statutory requirements. In this case, especially the pressurised components and connecting elements should be checked for wear and corrosion.</p>   |
| <br>NOTE | <p>If the valve uses fluids that are harmful to the people or the environment, then the operator should fix a warning note very close to the valve.</p>   |
| <br>NOTE | <p>Use of the valve other than as intended is not permitted.</p>  |
| <br>NOTE | <p>The valves should only be operated within their limits of design and layout.</p>   |
| <br>NOTE | <p>No modifications must be carried out on the valve without the consent or approval of the manufacturer.</p>   |
| <br>NOTE | <p>For installation, operation, maintenance and assembly of the valve, the currently applicable standards, guidelines, accident-prevention regulations, reliability regulation, plant-specific safety regulations, site regulations and technical documents should be followed.</p>   |



### 3 Packing



- The valves should be sent from the works in a dry and good condition. The port holes should be closed with plastic caps or such like.
- Depending on the size on a pallet, the valve is shipped in a skid-carton or a wooden crate. The warnings on the packing must be followed. Special packing and conservation for larger periods of time must be indicated separately in the purchase order.
- Transportation, unloading and lifting of the delivery unit must be carried out with the required caution as well as using tools that correspond to the weight and the dimensions.
- Check the packaging for integrity at the time of delivery.
- Check the scope of supply for completeness.
- Check whether the identification of the valve on the name plate (see Chapter 5.8 Identification of the valve) corresponds to your order.
- In the case of damage, incomplete or incorrect delivery, contact your forwarding agent, the person engaged for transportation or us.



NOTE

We accept no liability for damages resulting from improper transportation, loading or unloading.

## 4 Transport and storage



|  |  |
|--|--|
| <br>WARNING | Improper transportation can cause property damages to a significant extent.                    |
| <br>WARNING | Appropriate transportation and lifting devices must be used. For weights, see dimension sheet. |
| <br>WARNING | The valve should be protected against external force (impact, shock, vibration, etc.).         |

### During transportation and intermediate storage, the following points should be respected.

- The valve should be stored in a dry, clean, well-ventilated and safe place until the assembly.
- The transportation and storage temperature should be between -10 °C and +50 °C. When stored below -10 °C, our winter inerting regulations must be observed.
- Any damage to the corrosion protection (painting) should be immediately rectified.
- If the storage is to be done for a longer period of time (longer than 6 months), special packing and conservation must be specially planned by you.
- Keep the valve using the factory protective measures (foils, boxes, pallets, etc.). The flange plugs must be removed only at the place of operation.
- Installation position, dimensions and weight of the valve should be documented in the dimension sheet and complied with.
- In the case of valves with a weight of over 25 kg, it is necessary to ensure that mounting lugs and lifting tools are available above the mounting location to a sufficient height.

## 5 Description and technical data

### 5.1 Intended Use

|  |   |
|--|---|
| <br>DANGER  | <p>The valves should only be operated within their limits of design and layout. These limits should be taken from the nameplate. They should be operated only within their specified performance limits (see technical data). In particular, the values for the pressure rating, the design pressure, the design temperature and test pressure must not be exceeded, since it may otherwise lead to overloading of the valve.</p> <p>Only those media must be used, against which the materials are resistant. Dirty media or applications of the valve outside the specified values can lead to component damages.</p> |
| <br>WARNING | <p>In the piping system, the usual flow velocities for continuous operation should not be exceeded. Operating conditions such as vibration, pressure surges, cavitation and ingredients of solid materials (in particular abrasive materials) in the medium must be clarified with the manufacturer in advance.</p>   |

## 5.2 Structure of the valve type SUL

### 5.2.1 Valve type SUL without non-return function

The minimum quantity valve, or the automatic recirculation valve (ARV), consists of the lower housing and upper housing (item 01 and item 02) with the respective main attachment flanges. The bypass outlet is arranged horizontally on the lower part (item 01) side. In the interior there is the non-return plug (item 07), as well as the hydraulically operating control and throttle section (items 10 - 13).

The valve housing is made of cast steel or highgrade cast steel and the valve inner parts are machined from forged stainless steel.

The selection of the housing materials depends on the design pressure, the design temperature and the medium. The standard trim parts are manufactured from stainless steel with a chromium content of at least 13%. Other materials for housing and trim parts are possible on request. The selection of the seal materials depends on the medium and the temperature.

The valves of the type SUL are available in standard sizes from DN 25 (1") up to DN 250 (10") and pressure ratings of PN 10 to PN 63 or class 150 to class 300.

Flanges conform to EN or ASME standards. Flanges in accordance with other standards and regulations (e.g. ISO, BS, JIS, NF) as well as connections with welding ends are also possible on request.

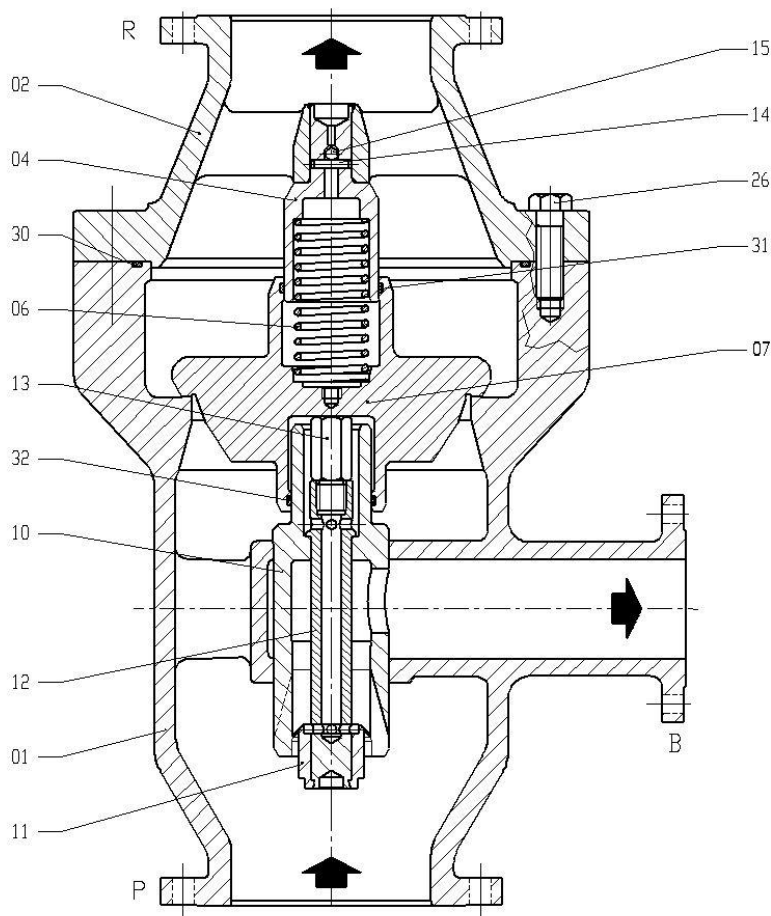

| Housing |                 |
|---------|-----------------|
| Item    | Description     |
| 01      | Lower body      |
| 02      | Upper body      |
| 04      | Guide bushing   |
| 06      | Spring          |
| 07      | Non-return plug |
| 10      | Vortex bushing  |
| 11      | Bushing         |
| 12      | Stam            |
| 13      | Adjustment bolt |
| 14      | Pin             |
| 15      | Ball            |
| 26      | Hex. Screw      |
| 30      | O-ring          |
| 31      | Guiding ring    |
| 32      | Guiding ring    |

**Figure 1** Sectional drawing and parts list of the valve type SUL without non-return function (example)

**5.2.2 Valve type SUL with non-return function**

The SUL valve with non-return function also has the following components in the minimum flow connection:

Non-return housing (item 33), non-return piston (item 34), web (item 35),

slide bushing (item 36), o-ring (item 37) coil spring (item 38) and a scraper (item 17 optional).

These components contribute to the non-return function in the minimum delivery, in order to avoid a backflow of the minimum quantity delivery flow.

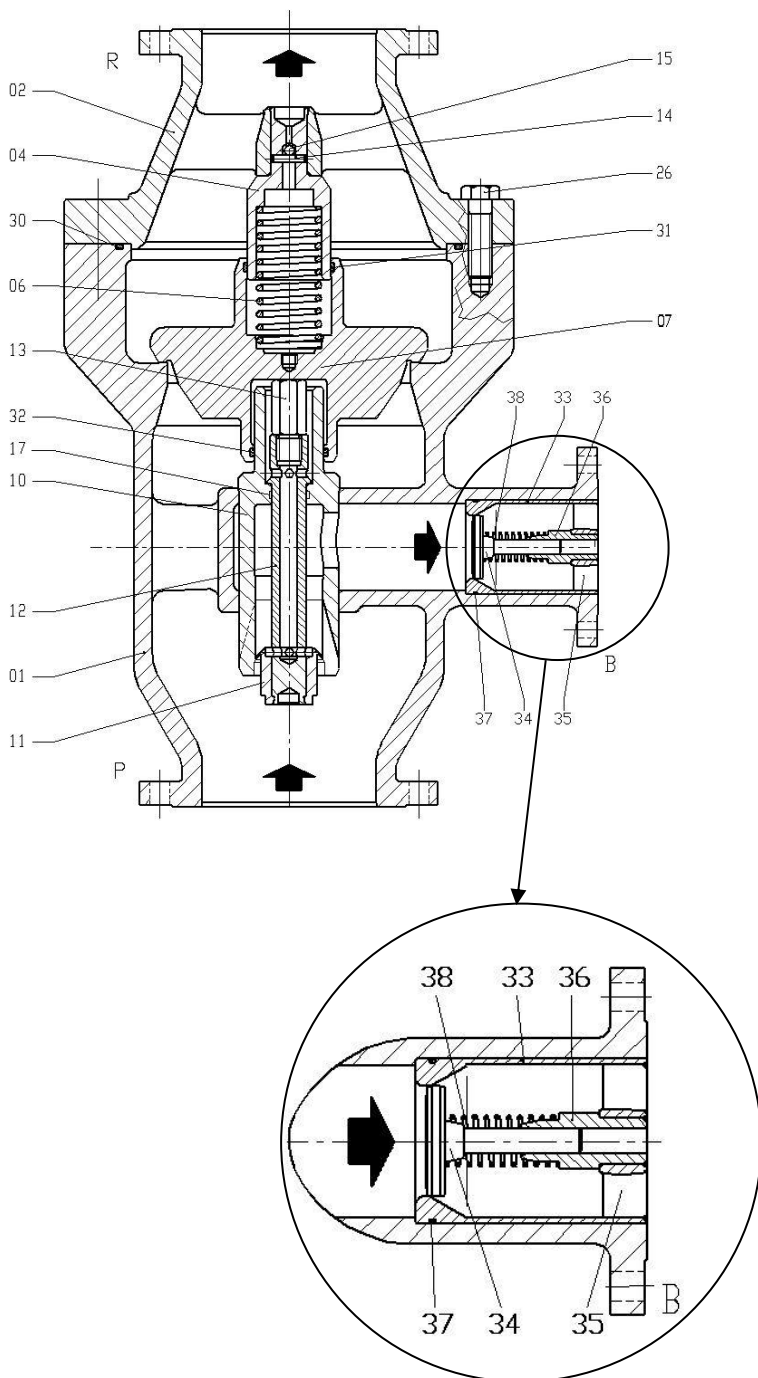

| Housing |                    |
|---------|--------------------|
| Item    | Description        |
| 01      | Lower body         |
| 02      | Upper body         |
| 04      | Guide bushing      |
| 06      | Spring             |
| 07      | Non-return plug    |
| 10      | Vortex bushing     |
| 11      | Bushing            |
| 12      | Steam              |
| 13      | Adjustment bolt    |
| 14      | Pin                |
| 15      | Ball               |
| 17      | Scraper            |
| 26      | Hex. Screw         |
| 30      | O-ring             |
| 31      | Guiding ring       |
| 32      | Guiding ring       |
| 33      | Non-return housing |
| 34      | Non-return piston  |
| 35      | Web                |
| 36      | Slide bushing      |
| 37      | O-ring             |
| 38      | Spring             |

**Figure 2** Sectional drawing and parts list of the valve type SUL with non-return function (example)

### 5.3 Functioning of the valve type SUL

This automatic recirculation valve is a flow-actuated valve, which automatically maintains the minimum flow required for the reliability of the pump and thus protects the centrifugal pumps against overheating, loss of stability and cavitation.

The application range of the series SUL extends, independent of the temperature, to a differential pressure of up to 20 bar. As soon as the main delivery flow falls below a certain value, then the valve opens its bypass so far, that always the required minimum delivery of the pump is bypassed, even if the main delivery flow is zero.

By the main delivery flow to the process, the non-return plug (item 07) (item numbers of the components, see pages 12 and 13) is brought to a certain vertical position and its position changes depending on the pump flow. The bypass comprises the vortex bushing (item 10), bush (item 11) and spindle (item 12) follows the stroke of the non-return plug (item 07) due to the hydraulic forces. The flow cross-section is determined by the size of the holes in the vortex bushing (item 10).

The opening of bypass (item 10-13) increases linearly, as the non-return plug (item 07) goes to the closed position. When the non-return plug (item 07) is fully closed the entire minimum quantity is passed through the bypass. Conversely, the bypass is completely closed and the full pump flow is fed to the system if the non-return plug (item 07) is in the uppermost position. As a result of this modulated control, the sum of delivery flow and minimum volume remains approximately constant.

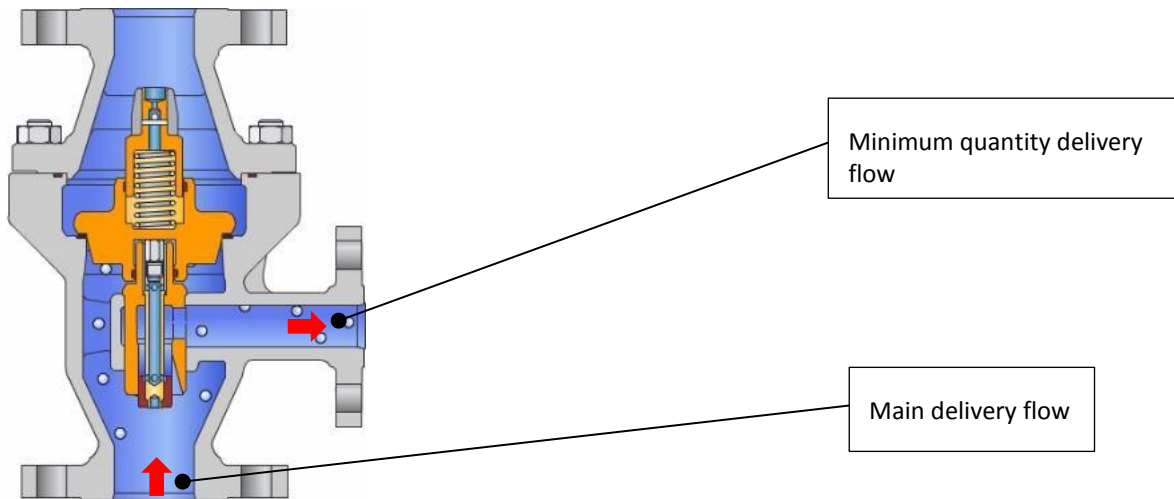

Figure 3 SUL valve with closed non-return plug and open bypass

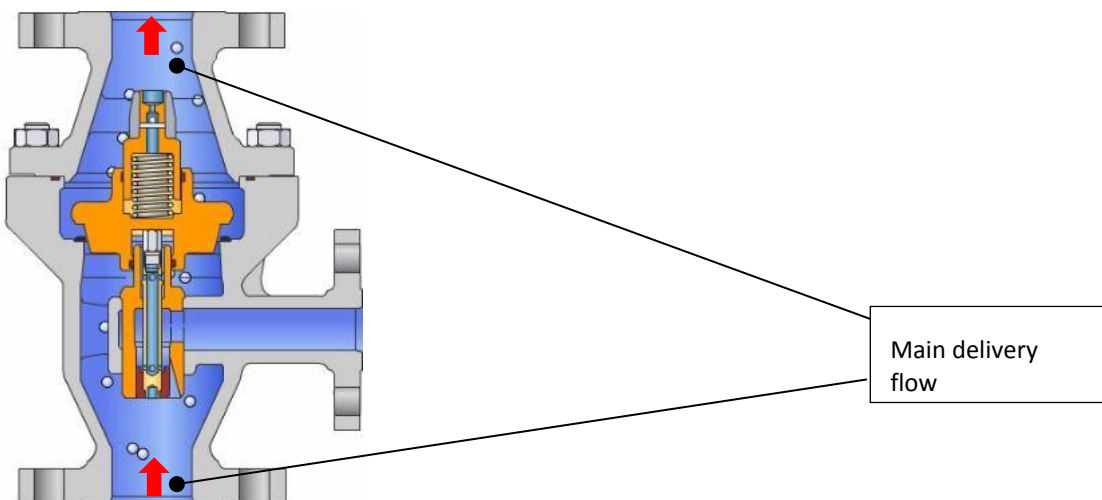

Figure 4 SUL valve with open non-return plug and closed bypass (switch point)

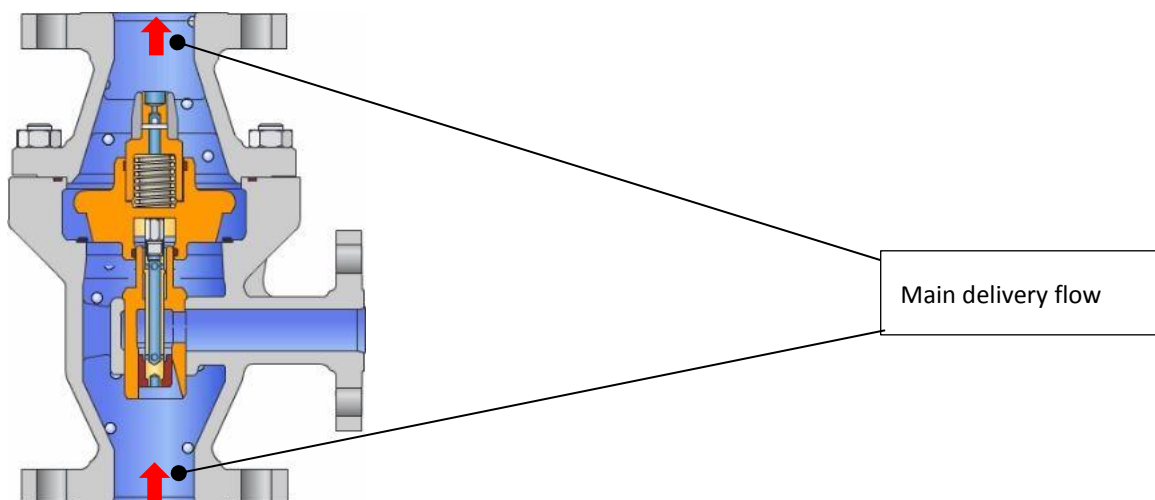

Figure 5 SUL valve with open non-return plug in maximum flow level and closed bypass

### 5.4 General notes regarding operation of the valve

In general, unless otherwise agreed, the automatic pump protection valve is designed for a normal operational requirement of the process volume flow from 40% to 100%.

The operating conditions considered in the valve design are documented in the order through associated data sheet.

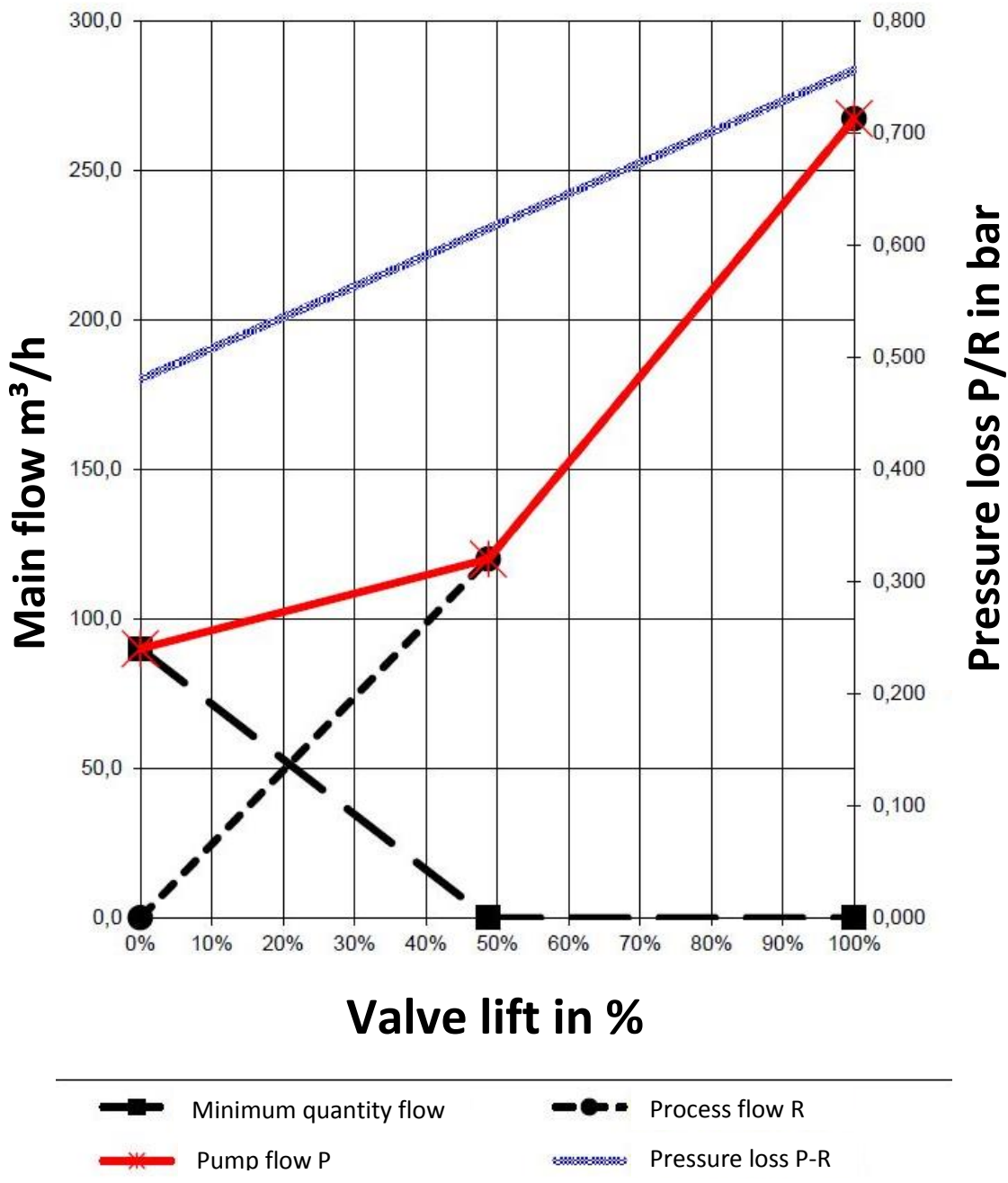

Figure 6 Characteristic curve of a minimum quantity valve of the type SUL



## 5.5 Normal operational requirement

The valve is normally used in a load range between 40% and 100% of the rated flow. The automatic recirculation valve is mainly used in the limited start-up and withdrawal operations and it assumes here the modulating bypass control. The maximum differential pressure between the valve SUL and the bypass system is up to 20 bar.

If the order documents and the data sheet do not specify any operational requirement, then the normal operational requirement is presumed and considered. Any deviating condition must be explicitly agreed upon.

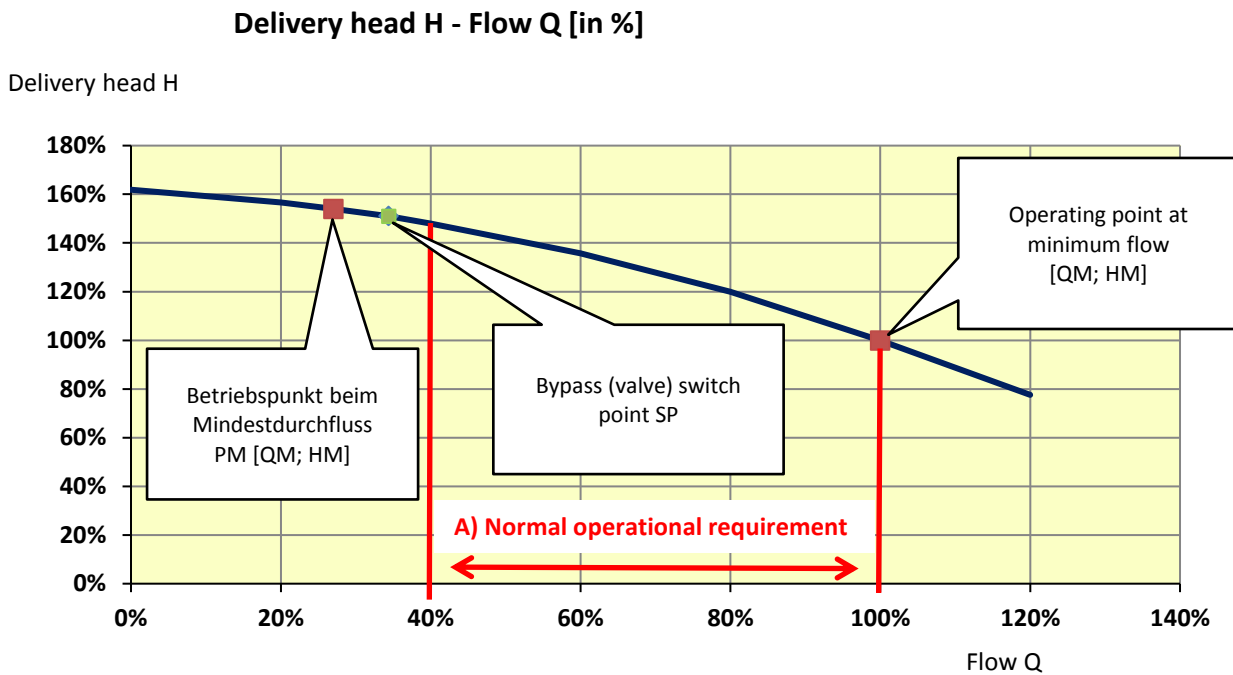

Figure 7 Normal operational requirement

## 5.6 Identification of the valve

Specific valve data are indicated on the valve nameplate as per sample below. The nameplate is fixed on each valve housing and should not be removed. The identification includes at least the following details:

- Name of the manufacturer
- Nominal width
- PN designation
- Maximum allowable pressure PS
- Maximum allowable temperature TS
- Test pressure PT
- Material
- Order number (serial number)
- Type of valve
- Year of manufacture
- CE marking (if necessary and possible)

Specific valve data are indicated on the valve nameplate as per sample below:

|                        |              |  |        |
|------------------------|--------------|--|--------|
| <b>SCHROEDAHL GmbH</b> |              | D-51580 Reichshof - Mittelagger                                    |        |
| Tel.: +49-2265-9927-0  |              | Internet: <a href="http://www.schroedahl.de">www.schroedahl.de</a> |        |
| DN                     | 100          | PN   | 40     |
| PS                     | 24           | bar TS   | 240 °C |
| PT                     | 60           | bar  | date   |
|                        |              | mat.   | 1.0619 |
| order                  | 4000700.1-1  |  | item.  |
| type                   | SUL114FHR-CS |  | year   |
|                        |              |  | 2017   |
| <i>Made in Germany</i> |              |  |        |

**Figure 8** Example of a nameplate of the valve type SUL





In the case of spare part deliveries, basically the order number (serial number), the type and the part number from the parts list should be mentioned.



If within an order item several valves are supplied, then the nameplates should be additionally marked with a serial number beginning with "1". This ensures that the corresponding valves can be related.

## 6 Installation of the valve in the plant

### 6.1 Please observe before the installation in the pipeline!

|   |  |
|---|--|
| <br>DANGER | <p>The valve must be installed when the pipeline is in a cooled condition. Valves, which are operated with high or low temperatures (<math>T &gt; 60\text{ °C}</math> or <math>T &lt; 0\text{ °C}</math>), must be protected against accidental contact.</p> |
|---|--|

|  |   |
|--|---|
| <br>WARNING   | <p>The valve should be installed in the pipeline according to the flow arrows marked on the housing. It should be ensured that the flange pads and the seals are clean and free of damages, before tightening the bolts with the torque wrench for the appropriate tightening torque. Use only the provided bolts and seals of the manufacturer for installation of the valve in the plumbing system.</p> |
| <br>WARNING   | <p>Remove flange covers, if present.</p>  |
| <br>WARNING  | <p>The inner parts of the valve and the pipeline must be free of foreign particles.</p>   |
| <br>WARNING | <p>Installation position of the valve with respect to the flow should be correctly maintained; see identification on the valve.</p>   |
| <br>WARNING | <p>For assembly work, appropriate transportation and lifting devices must be used. For weights, see catalogue sheet.</p>  |

|   |  |
|---|--|
| <br>NOTE | <p>In order to avoid damages to the flange pads and/or bolts, the valve assembly must be mounted in the plumbing system without stress.</p>  |
| <br>NOTE | <p>The valve should be installed as close as possible to the discharge flange of the centrifugal pump, preferably directly on the pump discharge flange. If this is not possible, the distance between the pump outlet and valve inlet should not exceed 3 m, in order to avoid frequency shocks caused by pressure pulsation of the medium.</p> |
| <br>NOTE | <p>In the case of indirect assembly on the pump discharge flange, the valve requires at the inlet a straight stretch of at least <math>2 \times DN</math> (no bends).</p>  |

**Unless agreed by a separate specification, the following should be considered prior to installation of the valve:**

- The valve is generally installed in a vertical position upwards in the flow direction and directly on the outlet flange of the pump. The recommended installation position is the vertical main passage, but also horizontal installation is possible on request. The bypass line should also be horizontal in the case of horizontal mounting.
- For high pressure applications from PN 64/class 300, a straight outlet stretch of at least 3 x DN is recommended at the bypass connection.
- Removal of the protective caps.
- Installation position, dimensions and weight of the valve should be documented in the dimension sheet and complied with.
- In the case of valves with a weight of over 25 kg, it is necessary to ensure that mounting lugs and lifting tools are available above the mounting location to a sufficient height.
- Prior to installation, the details of materials, pressure and temperature should be compared with the design and operating conditions of the plumbing system.
- Verification of identification on the nameplate with the operating data of the system. Any mismatch may lead to significant damages of valves, for which the manufacturer shall not be liable.
- Check that sufficient space (hoist for assembly, etc.) is available at the installation location for easy installation and removal.
- Check that the pipeline has been flushed and cleaned before installation. If not, the manufacturer accepts no liability for the resulting damages.
- Check that the distance between pipe ends matches the valve length.
- Plumbing system must be correctly installed so that mechanical stresses (e.g., forces and moments from pipeline expansions during the operation, vibrations, etc.) do not act on the valve housing during installation and operation.
- Pipeline forces can be applied by the valve only to the extent, as they were considered by the specified pressure classes (flange geometry) and selection of material while planning the pipe system. Additional requirements need a special confirmation.

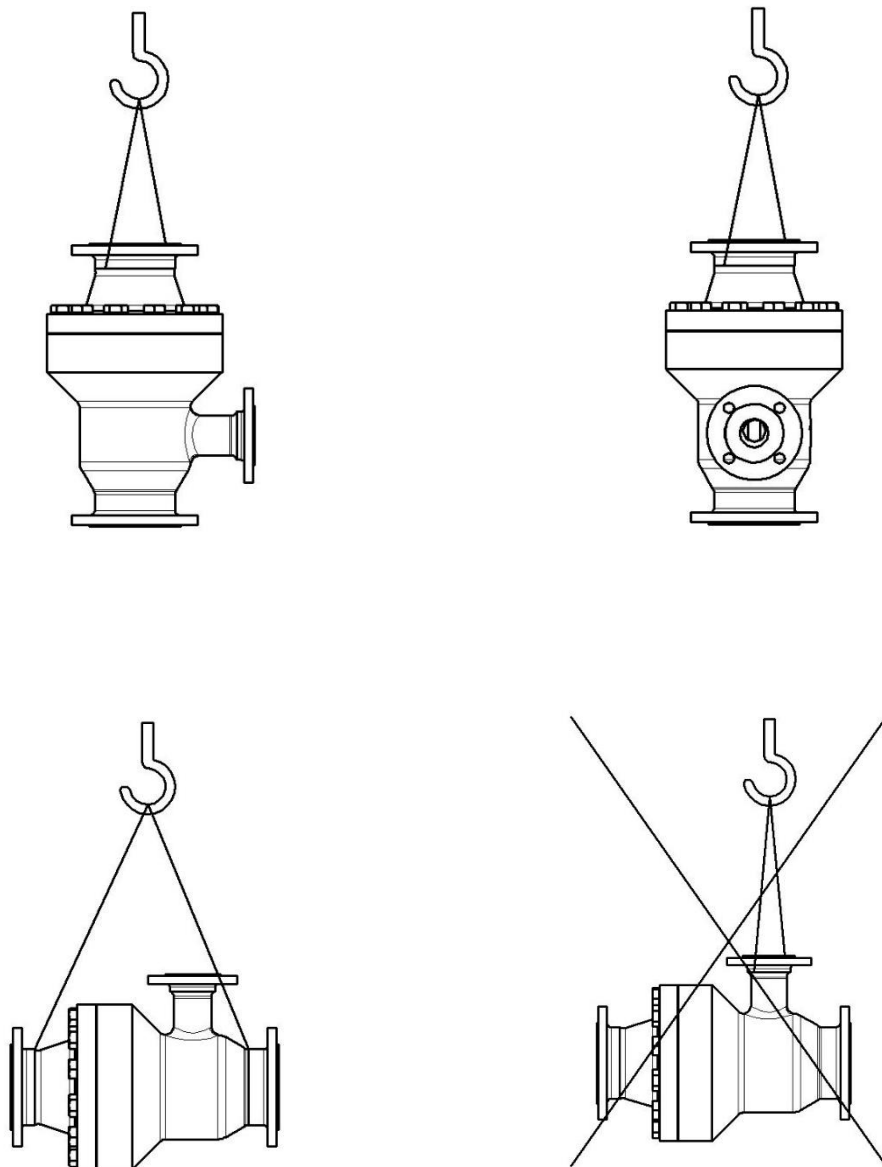

**Figure 9** Typical representation of the handling options when installing the valve

**Valve installation:**

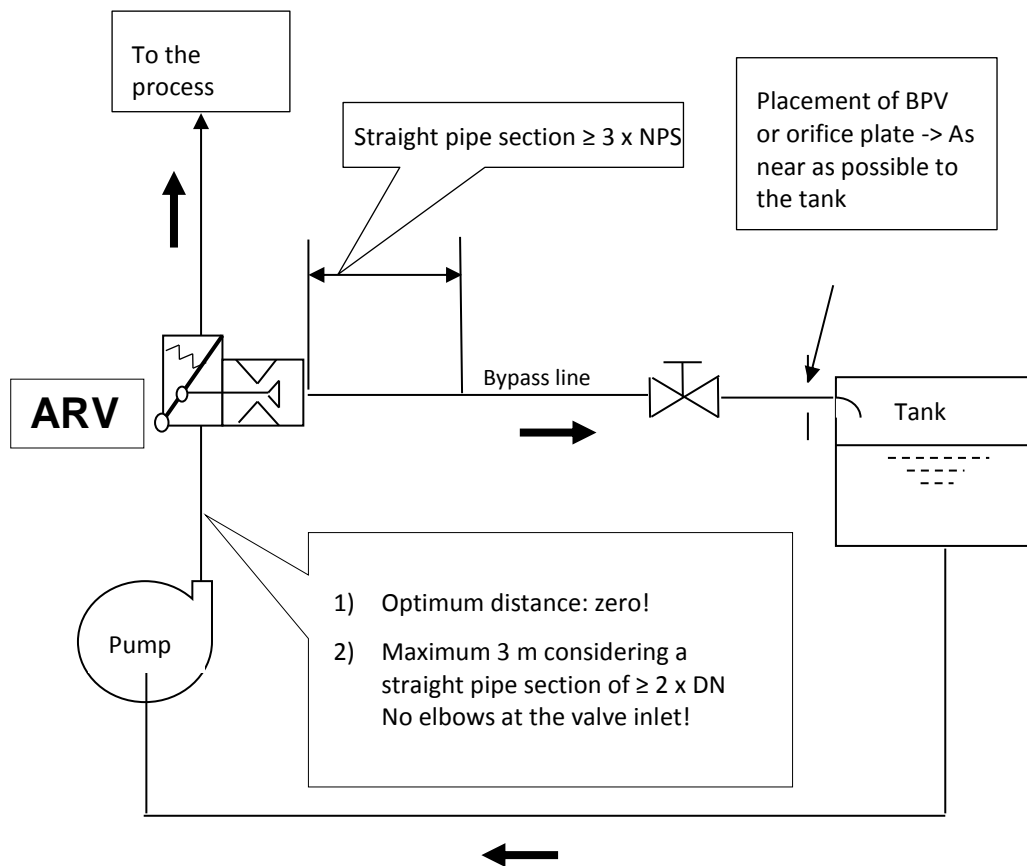

**Figure 10** Schematic representation of the installation conditions for the pump protection valve

|                          |  |
|--------------------------|--|
| <p><b>!</b><br/>NOTE</p> | <p>To prevent low frequency shocks caused by pulsation of the medium, the distance between pump outlet and valve inlet should not exceed 3 m. Also a straight inlet pipe stretch should be provided. Deviations should be clarified with the manufacturer.</p> |
| <p><b>!</b><br/>NOTE</p> | <p>The recommended filter at the pump outlet should have a maximum mesh size of 0.3 to 0.5 mm. During commissioning we recommend a smaller filter mesh size (e.g. 0.1 mm).</p>   |

## 6.2 Installation of the valve

### 6.2.1 Valve with flanges

The sealing surfaces of the attachment flanges must be clean and without damages.

Flange gaskets must be mounted centrally and should not constrict the flow space.

The flanges should be carefully aligned before bolting. All provided flange holes must be used for the flange attachment. The bolts must be tightened according to the specifications given in the plumbing plan.

### 6.2.2 Valve with welding ends



NOTE

It is pointed out that the valves are welded by qualified personnel with appropriate tools and according to established engineering practices. The responsibility rests with the plant operator.

The welding process should be chosen according to the specifications given in the plumbing plan.

While welding the valve, the valve housing must not be used to test the welding electrode or the polarity.

During the welding process and any subsequent heat treatment required, the trim parts must be removed. If elastomeric seals are provided between the lower part (item 01) and the upper part (item 02), then they must be removed.

## 7 Pickling and flushing

The materials used in the valve are in general suitable for pickling. In practice, during pickling and flushing, impurities and foreign objects pass through the valves. This may result in damages to the trim parts.

During the flushing operation, the trim parts of the valve may be damaged by foreign objects.

Therefore, we recommend to replace the trims with appropriate protective inserts prior to pickling or flushing.

After pickling and flushing, the valve must be cleaned and the seals must be replaced.



NOTE

Any foreign object, which remains in the valve after pickling or flushing, may damage the valve.

## 8 Disassembly

**DANGER**

The valve must be without pressure, drained and in cooled condition.

Notes given in the corresponding dimension sheet must be followed

### 8.1 Valves with flanges

1. Suspend the valve, but do not lift.
2. Remove the flange bolts.
3. Remove the valve from the pipeline.
4. Store the valve in a protected condition.

**NOTE**

The flange sealing surfaces of the valve must not be damaged during the removal of the pipeline and must be closed with suitable plastic caps or such like.

### 8.2 Valves with welding ends

For valves with welding ends, the housing cannot be removed. This requires a mechanical destruction of the connection of housing and pipeline or the plumbing system allows a displacement of the pipe parts (responsibility of the plant operator).



## 9 Disassembly and assembly of the valve and the bypass

### 9.1 General assembly and disassembly information

Due to the high precision and close tolerances, maximum cleanliness and proper handling should be ensured. Any contamination or damage puts the proper operation in jeopardy.

No special tools are required for the assembly or disassembly of the valve.









Before disassembling the valve, the valve must be without pressure, drained and in cooled condition! Also, remember that the piping on the bypass unit is part of the high-pressure stage!





#### Before beginning any work ensure the following:



- Work correctly and safely according to the applicable regulations as well as the warnings and notes in this operating manual.
- Valves are pressure equipment! Any improper opening of the valve may endanger your health! The plant must be without pressure and dry before the disassembly.
- The pump must be switched off and secured against switching on again.
- Block the pipeline upstream and downstream of the valve.
- Remove the pressure from the pipe section.
- Allow the valve to cool to room temperature.
- Find out from the safety data sheet about the contents of the line and properly drain all hazardous and/or groundwater-endangering media from the blocked pipe section.
- Ensure the personal protective equipment prescribed in the safety data sheet.
- Immediately wipe away leakages and/or collect larger amounts or residues of medium in suitable containers.
- Always properly dispose of residues of medium (only in the case of hazardous media) in accordance with the Law on Waste. Never allow leakages/residues of medium seep into the sewerage system.

|  |  |
|--|--|
| <br>WARNING | Remove flange covers, if present.  |
| <br>WARNING | The interiors of the valve and the pipeline must be free of foreign particles.   |
| <br>WARNING | Installation position of the valve with respect to the flow should be correctly maintained; see identification on the valve.                     |
| <br>WARNING | For assembly work, appropriate transportation and lifting devices must be used. For weights see dimension sheet.                                 |
| <br>WARNING | Special safety regulations and risk analyses must be performed before any maintenance, so that risks to humans and the environment are excluded! |

|   |  |
|---|--|
| <br>INFORMATION | Please also refer to films on maintenance on our website:<br><a href="http://www.schroedahl.com">www.schroedahl.com</a><br><a href="http://schroedahl.com/en/media-services/maintenance-movie/SUL/">http://schroedahl.com/en/media-services/maintenance-movie/SUL/</a> |
|---|--|

## 9.2 Disassembly and inspection of the SUL valve

|  |   |
|--|---|
| <br>WARNING | <p>Before disassembling the valve, the valve must be without pressure, drained and in cooled condition! Also, remember that the piping on the bypass unit is part of the high-pressure stage!</p> |
| <br>WARNING | <p>The pipeline system must be ventilated after prior emptying in the case of corrosive, combustible, aggressive or toxic media.</p>  |

|   |   |
|---|---|
| <br>NOTE | <p>Please check before dismantling that sufficient spare parts and seals are available!</p> |
| <br>NOTE | <p>Spare parts have a delivery time of 12 weeks or more!</p>                                |

### Procedure for removal:

1. Depressurise the system!
2. Remove the valve from the system (pump pipelines).
3. Loosen the hexagon nuts (item 26)
4. Remove the upper body (item 02) from the lower body (item 01).

|  |   |
|--|---|
| <br>WARNING | <p>Observe the preload of the spring (item 06)!</p> |
|--|---|

5. Remove the coil spring (item 06) and pull out the non-return plug (item 07).
6. The bypass internals (item 10-13) can be removed using a tube from the valve inlet side (see Fig. 11).

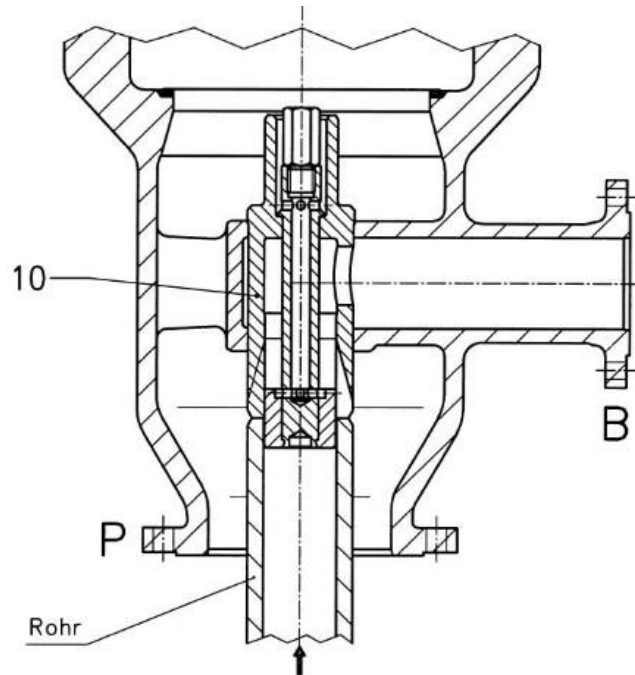

**Figure 11** bypass internals removal (item 10 - 13)

**Inspection:**

1. Clean all parts and check for any damages.
2. Check the bypass internals (items 10-13) as follows:
  - a) Check the unit for easy movement by pushing it back and forth.
  - b) When movement is stiff, clean the parts. If necessary put fine grind- paste between the vortex bushing (item 10) and the bushing (item 11) and lap-in both parts.
  - c) Clean the bypass internals once again.
  - d) When the internals are damaged they have to be exchanged as a complete set item 10 - 13).
3. In case of damages to the seating areas, the components must be replaced with new ones.

### 9.3 Assembly of the valve type SUL

#### Procedure for assembly:

1. Assemble the valve in reverse order.
2. Before the bypass internals are installed, the vortex bushing (item 10) has to be coated with LOCTITE (see Fig. 12).
3. Assembling the bypass internals by pressing on the vortex bushing (item 10).  
A suitable pipe piece must be used for this purpose.
4. Please make sure that the outlet holes in the vortex bushing (item 10) are pointed in the direction of the bypass outlet
5. Caution! The movement of the unit (item. 11, 12, 13) in the vortex bushing (item 10) must be very smooth
6. With every disassembly the seals/guide rings (item 30 - 32) must always be replaced
7. Carefully set the upper body (item 02) on the lower body (item 01) and fasten using the hexagon bolts (item 26).
8. Tighten the hexagon bolts evenly with the required torque (see Chap. 9.4) using a torque wrench.

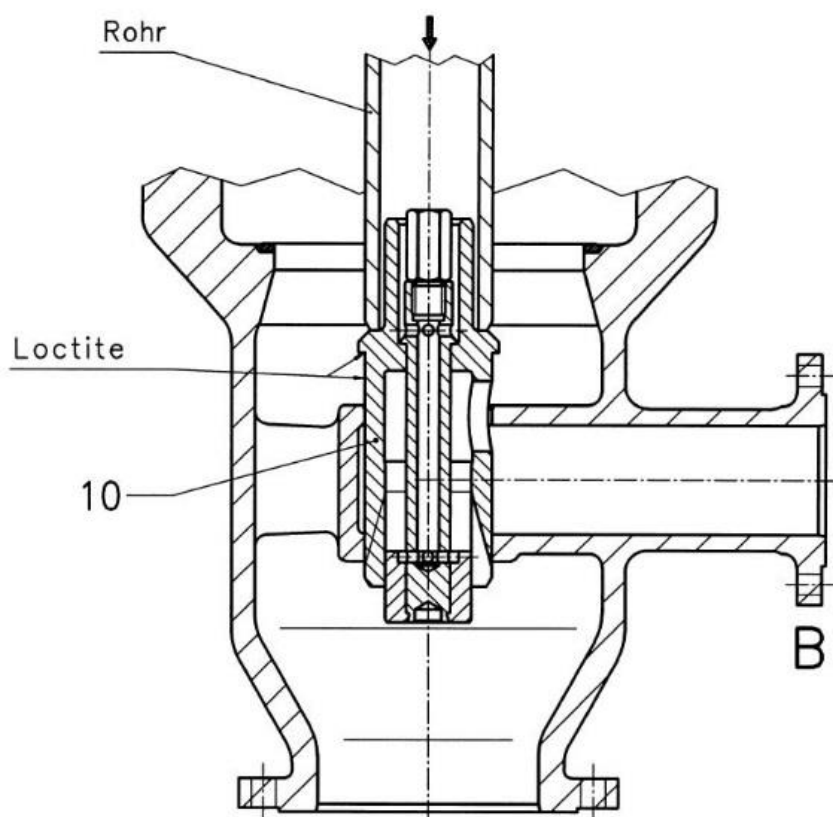

**Figure 12** bypass internals installation (item 10 - 13)

## 9.4 Mounting torque in Nm for hexagon bolts (item 26)

If no data have been indicated on assembly tightening torque for expansion bolts or shoulder studs in the drawings accompanying the order, then the tables below apply.



NOTE







Hexagon bolts (item 26) should be tightened only in the unpressurised and cool condition of the valve with the appropriate tightening torque according to Table 1.

| Thread size | Bolt material |        |        |        |
|-------------|---------------|--------|--------|--------|
|             | 8.8           | 1.7225 | 1.7709 | 1.4923 |
| M12         | 66            | 89     | 55     | 60     |
| M16         | 162           | 184    | 135    | 147    |
| M20         | 316           | 360    | 264    | 288    |
| M24         | 547           | 621    | 455    | 497    |
| M27         | 801           | 910    | 668    | 728    |
| M30         | 1,086         | 1,234  | 905    | 987    |
| M33         | 1,478         | 1,680  | 1,232  | 1,344  |
| M36         | 1,899         | 2,158  | 1,582  | 1,726  |
| M39         | 2,457         | 2,792  | 2,048  | 2,234  |
| M42         | 3,040         | 2,994  | 2,533  | 2,764  |

**Table 1** Mounting torque in Nm for hexagon bolts (item 26)

## 10 Commissioning

The valve is commissioned subsequent to commissioning of the pump. When the pump starts, the prescribed amount of minimum flow automatically flows through the bypass of the valve when the main shut-off valve in the main line is closed. By actuating the shut-off valve in the main line the opening and closing of the bypass can be controlled. The switch point is acoustically perceptible (use a stethoscope or a screwdriver to hear the flow) or check the flow from the flow and pressure readings in the plant.



|   |  |
|---|--|
| <br>WARNING  | The valves must not be operated outside the permissible fields of application. The limits of usage can be found on the nameplate.  |
| <br>WARNING  | Residues in pipelines and valves (such as dirt, welding beads, etc.) cause leakages or damages.  |
| <br>WARNING  | When operating at high (> 50 °C) or low (< 0 °C) temperatures of the media, there is risk of injury when touching the valve. If necessary, put up warnings or make insulation protection!  |
| <br>WARNING | Before each commissioning, after reworks and repairs, proper completion of all installation works must be ensured.   |
| <br>NOTE   | If the valve is operated with other operating data, then increased wear of the parts should be expected, depending on the variation in the design data.<br>In the case of changed operating data, we recommend to consult the manufacturer, so that the valve can be specifically set to the operating conditions. |
| <br>NOTE   | After commissioning, an inspection of the valve is recommended, in order to ensure that there are no damages to the valve!   |

## 11 Maintenance

The valve of the type SUL has been so designed, that no special maintenance is required. It is confined to cleaning of trim parts during regular maintenance of the pump or similar plant components and regular replacement of seals, at least every 2 years. When disassembling the valve, it is to be ensured that new set of seals are used.

The valve should be checked regularly.

We recommend a maintenance after commissioning and periodic changing of the seals, at least every 2 years. In addition, we recommend to maintain a bypass set in stock.

|  |  |
|--|--|
|  <p>DANGER</p>  | <p>The valve is under pressure and usually at high temperature during operation.<br/><b>Non-compliance can result in death, serious bodily injuries or property damages.</b></p> <ul style="list-style-type: none"> <li>• Assembly and maintenance work can only be carried out when the plant has been shut off and the valve is without pressure and has cooled down.</li> <li>• The plant should be commissioned again only after completion of the installation and maintenance work.</li> </ul> |
|  <p>DANGER</p> | <p>The valve can also still contain the medium in a pressure-free condition.<br/>Protection measures should be taken from the safety data sheets of the manufacturer of the medium!</p> <p><b>Warning:</b> Serious injuries possible!</p> <p>Suitable protective clothing is required for assembly and maintenance work.</p>   |



|                  |   |
|------------------|---|
| <b>!</b><br>NOTE | Servicing and maintenance works must be carried out only by qualified personnel!                            |
| <b>!</b><br>NOTE | Standard spare parts have a delivery time of 12 weeks or more!  |
| <b>!</b><br>NOTE | The operator is responsible for compliance with the safety regulations applicable at the place of erection! |

## 12 Inspections and inspection schedules

### 12.1 Inspections

The valve has been designed and manufactured, such that maximum quality and service friendliness is achieved. This results in a lower need for care and maintenance of the valve.

|                  |  |
|------------------|--|
| <b>!</b><br>NOTE | The valve should be regularly subjected to a safety check in accordance with the company-specific safety regulations and statutory requirements. In this case, especially the pressurised components and connecting elements should be checked for wear and corrosion. |
|------------------|--|

Necessary checks before commissioning and after significant changes in the plant and repetitive checks should be carried out by the operator as required by the national regulations.

A test of valve performance can be performed ideally with the original pump. The Kv/Cv value testing can be performed on our test bench and certified.

Please contact SCHROEDAHL for additional information.

### 12.2 Inspection schedules

We recommend inspection of the valve according to the Table below during the regular maintenance of the pump or pump systems, when plant is not operating, or at the latest every 2 years.

| Components            | Items |       |       |       |       |    | Inspection time  | Measures                       |
|-----------------------|-------|-------|-------|-------|-------|----|--|--------------------------------|
| Housing               | 01    | 02    |       |       |       |    | Maintenance of the pump or pump systems<br>or<br>or when the plant is not operating<br>or<br>every 2 years | Inspection                     |
| Internal parts        | 04    | 06    | 07    | 14    | 15    | 17 |  | Inspection                     |
| Bypass internal parts | 10    | 11    | 12    | 13    |       |    |  | Check and replace if necessary |
|                       | 33 *) | 34 *) | 35 *) | 36 *) | 38 *) |    |  |                                |
| Hexagon bolts         | 26    |       |       |       |       |    |  | Inspection                     |
| Seals/ Glyd-rings     | 30    | 37 *) |       |       |       |    |  | Replacement                    |
| Guiding rings         | 31    | 32    |       |       |       |    | Inspection   |                                |

\*) For valves with non-return function in the bypass

**Table 2** Test intervals for the components of the valve type SUL

## 13 Causes and remedies in the event of failures

In the case of failures or improper operation it is to be checked whether assembly and adjustments have been carried out and completed in accordance with this operating manual.

|  |   |
|--|---|
| <br>WARNING | <p><b>Before beginning any work ensure the following:</b></p> <ul style="list-style-type: none"><li>• Work correctly and safely according to the applicable regulations as well as the warnings and notes in this operating manual.</li><li>• Valves are pressure equipment! Any improper opening of the valve may endanger your health! The plant must be without pressure and dry before the disassembly.</li><li>• The pump must be switched off and secured against switching on again.</li><li>• Block the pipeline upstream and downstream of the valve.</li><li>• Remove the pressure from the pipe section.</li><li>• Allow the valve to cool to room temperature.</li><li>• Find out from the safety data sheet about the contents of the line and properly drain all hazardous and/or groundwater-endangering media from the blocked pipe section.</li><li>• Ensure the personal protective equipment prescribed in the safety data sheet.</li><li>• Immediately wipe away leakages and/or collect larger amounts or residues of medium in suitable containers.</li><li>• Always properly dispose of residues of medium (only in the case of hazardous media) in accordance with the Law on Waste. Never allow leakages/residues of medium seep into the sewerage system.</li></ul> |
|--|---|

|   |  |
|---|--|
| <br>NOTE | For troubleshooting, follow the safety instructions in Chapter 2.3.! |
|---|--|

If the measures below do not lead to a satisfactory result, the manufacturer/supplier must be contacted.

| Defects                  | No. | Possible causes  | Measures  |
|--------------------------|-----|--|---|
| <b>1. No flow</b>        | 1.1 | <ul style="list-style-type: none"> <li>• Flange covers not removed</li> </ul>  | <ul style="list-style-type: none"> <li>• Remove flange covers</li> </ul>  |
|                          | 2.1 | <ul style="list-style-type: none"> <li>• Contaminated strainer (dirt trap)</li> </ul>  | <ul style="list-style-type: none"> <li>• Clean or replace the strainer</li> </ul>   |
|                          | 2.2 | <ul style="list-style-type: none"> <li>• Blockage in the plumbing system</li> </ul>  | <ul style="list-style-type: none"> <li>• Check the plumbing system</li> </ul>   |
|                          | 2.3 | <ul style="list-style-type: none"> <li>• Valve designed for 40% - 100% operating condition, but operation below 40% or occasionally below 40% during the start-up and shut-down</li> </ul> | <ul style="list-style-type: none"> <li>• Communicate operating data and duration of operation of the plant to the manufacturer, in order to verify that the parameters agree with the design data of the valve. In the case of deviation of operating data and design data of the valve, they will be modified and adapted by the manufacturer</li> </ul> |
|                          | 2.4 | <ul style="list-style-type: none"> <li>• Wear or damage of the valve or the bypass internals (item 10-13) due to vapour and condensation shocks and cavitation</li> </ul>                  | <ul style="list-style-type: none"> <li>• Replacement of the valve or the bypass internals</li> </ul>  |
| <b>2. Low valve flow</b> |     |  |   |

|                                 |     |  |   |
|---------------------------------|-----|--|---|
|                                 | 2.5 | <ul style="list-style-type: none"> <li>Back pressure in the bypass line set incorrectly or too low or BPV (back pressure controller) is defective</li> </ul> | <ul style="list-style-type: none"> <li>At high pressures in the bypass line, the pressure must be about 4 bar higher than the vapour pressure of the medium. Increase in temperature (15 °C to 20 °C) of the medium due to the pump must be taken into account</li> <li>Increase the pressure in the tank or move BPV directly (as close as possible) to the tank</li> <li>Investigation of the vapour content after the BPV and the arrangement of the pipe to the tank</li> <li>Checking the dimensions of the BPV with existing operating data of the plant by the manufacturer</li> </ul> |
|                                 | 2.6 | <ul style="list-style-type: none"> <li>The valve not installed in direction of flow</li> </ul>   | <ul style="list-style-type: none"> <li>Install the valve in the direction of flow</li> </ul>  |
| <b>3. Leakage of valve seat</b> | 3.1 | <ul style="list-style-type: none"> <li>Non-return plug (item 07) does not close fully</li> </ul>   | <ul style="list-style-type: none"> <li>Remove foreign objects in the seating area. If there is corrosion or wear, remove the valve and send or request for manufacturer's service</li> </ul>  |
|                                 | 3.2 | <ul style="list-style-type: none"> <li>Valve seat at the lower body (item 01) or non-return plug (item 07) damaged due to foreign objects</li> </ul>         | <ul style="list-style-type: none"> <li>Replace the valve or rework the sealing surfaces of the valve seat in the lower body (item 01) (grinding) and replace the non-return plug (item 07)</li> </ul>   |
|                                 | 3.3 | <ul style="list-style-type: none"> <li>Too small back pressure <math>P_N</math></li> </ul>   | <ul style="list-style-type: none"> <li>See para. 2.5</li> </ul>   |

|   |     |  |  |
|---|-----|--|--|
| <b>4. Leakage between upper part (item 2) and lower part (item 1)</b> | 4.1 | <ul style="list-style-type: none"> <li>Incorrect tightening torque of hexagon bolts (item 26) or too small pressing force on the seal (item 30)</li> </ul> | <ul style="list-style-type: none"> <li>Check tightening torques of the hexagon bolts (item 26) (see chapter 9.4) and, if necessary, retighten it with the correct tightening torque (using torque wrench)</li> </ul> |
|   | 4.2 | <ul style="list-style-type: none"> <li>Uneven seal pressure</li> </ul>   | <ul style="list-style-type: none"> <li>Set a uniform gap by tightening the hexagon bolts (item 26) in the correct sequence (through torque wrench)</li> </ul>  |
|   | 4.3 | <ul style="list-style-type: none"> <li>Damaged seal (O-ring, item 30)</li> </ul>   | <ul style="list-style-type: none"> <li>Replacement of damaged seal (O-ring, item 30)</li> </ul>  |
| <b>5. Leakage of the non-return unit (item 33-38)</b>                 | 5.1 | <ul style="list-style-type: none"> <li>Components of the non-return unit (item 33-38) are worn or defective</li> </ul>                                     | Check components of the non-return unit (item 33-38) for wear and replace if necessary   |
|   | 5.2 | <ul style="list-style-type: none"> <li>Damaged seal (o-ring, item 37) on non-return housing (item 33)</li> </ul>   | <ul style="list-style-type: none"> <li>Replace the damaged seal (o-ring, item 37) on non-return housing (item 33)</li> </ul>   |
| <b>6. Bypass of the valve is leaking</b>                              | 6.1 | <ul style="list-style-type: none"> <li>Inner parts of the bypass (item 10 - 13) are worn and / or defective due to foreign bodies / impurities</li> </ul>  | <ul style="list-style-type: none"> <li>Inner parts of the bypass (item 10 - 13) must be checked and replaced if worn. In addition, a filter/strainer with maximum mesh width of 0.5 mm should be included</li> </ul> |

|   |     |  |   |
|---|-----|--|---|
| <b>7. Functional failure or jamming of the valve</b>                | 7.1 | <ul style="list-style-type: none"> <li>The plumbing system or medium not clean, possibly happens during commissioning</li> </ul>                             | <ul style="list-style-type: none"> <li>Inspection of pipeline and valve, whether contaminants are present and clean accordingly. In the case of contaminated water, an additional filter (max. mesh size 0.5 mm) should be installed</li> </ul> |
|   | 7.2 | <ul style="list-style-type: none"> <li>High wear or damage to the valve and/or bypass unit</li> </ul>  | <ul style="list-style-type: none"> <li>Replacement of the valve or worn components on the valve</li> </ul>  |
| <b>8. Oscillations, vibrations and pressure surges in the valve</b> | 8.1 | <ul style="list-style-type: none"> <li>Cavitation on the SUL bypass unit</li> </ul>  | <ul style="list-style-type: none"> <li>Check the back pressure and, if necessary, increase</li> </ul>   |
|   | 8.2 | <ul style="list-style-type: none"> <li>Minimum quantity of the pump too low</li> </ul>   | <ul style="list-style-type: none"> <li>Inform the manufacturer</li> </ul>   |
|   | 8.3 | <ul style="list-style-type: none"> <li>Dirty filter/strainer</li> </ul>  | <ul style="list-style-type: none"> <li>Clean or replace the filter/strainer</li> </ul>  |
|   | 8.4 | <ul style="list-style-type: none"> <li>Operating data of the system do not match with those given in the data sheet</li> </ul>                               | <ul style="list-style-type: none"> <li>Correct the operating data and forward the new operating data to manufacturer</li> </ul>   |
|   | 8.5 | <ul style="list-style-type: none"> <li>Damaged trim parts</li> </ul>   | <ul style="list-style-type: none"> <li>Inspection of the valve: clean or replace trim parts</li> </ul>  |
|   | 8.6 | <ul style="list-style-type: none"> <li>Distance between pump outlet and valve inlet &gt; 3 m</li> </ul>  | <ul style="list-style-type: none"> <li>Reduce the distance between pump outlet and valve inlet (&lt; 3 m)</li> </ul>  |
|   | 8.7 | <ul style="list-style-type: none"> <li>Bend in inlet pipe stretch</li> </ul>   | <ul style="list-style-type: none"> <li>Straight inlet pipe stretch (avoid bend)</li> </ul>  |
|   | 8.8 | <ul style="list-style-type: none"> <li>Pump characteristic not stable due to unforeseen pump switching operations or quick shut-downs of the pump</li> </ul> | <ul style="list-style-type: none"> <li>Check operation of the pump and stabilise pump characteristic</li> </ul>   |
|   | 8.9 | <ul style="list-style-type: none"> <li>Back pressure is too low and not stable</li> </ul>  | <ul style="list-style-type: none"> <li>Forward to the manufacturer the details of arrangement of the pipes in the main and bypass lines for checking</li> </ul>   |

**Table 3** Causes and measures for malfunctions of the valve type SUL

## Appendix

### A.1 Form for the malfunction

|  |  |   |
|--|--|---|
|   | <b>Schroedahl</b>  | <b>Meldung zur Betriebsstörung / Failure Report</b> |
| <b>Achtung<br/>Attention</b>   | Im Falle einer Störung ist dieses Formular ausgefüllt an Ihren Ansprechpartner bei Schroedahl zu senden.<br><i>In the case of a failure please fill out this report and send it back to your Schroedahl contact partner.</i> |   |
| <b>Allgemeine Information / General Information</b>  |  |   |
| <b>Anlagendaten / site information:</b><br><br><u>Name / Name:</u><br><br><u>Adresse / Address:</u><br><br><u>Land / Country:</u>  | <b>Ansprechpartner / contact partner:</b><br><br><u>Name / Name:</u><br><br><u>Tel.-Nr. / Tel.-No.:</u><br><br><u>Fax.-Nr. / Fax.-No.:</u><br><br><u>Email:</u>  |   |
| <b>Ventildaten / Valve information</b>   |  |   |
| <u>Schroedahl Ventiltyp / valve type:</u><br><br><u>Schroedahl Kommissionsnummer / serial number:</u><br><br><u>Datum der Inbetriebnahme / date of commissioning:</u><br><br><u>Betriebsstunden / operation hours:</u>   |  |   |
| <b>Aktuelle Betriebsdaten der Pumpe / Current pump operating data</b>  |  |   |
| <u>Zulaufdruck / suction pressure:</u><br><br><u>Gegendruck Bypass / back pressure bypass:</u><br><br><u>Enddruck / discharge pressure:</u><br><br><u>Fördermenge / flow rate:</u><br><br><u>Mindest kontinuierliche Prozessmenge / Minimum continuous process flow:</u><br><br><u>Temperatur Fördermedium / medium temperature:</u> |  |   |
| <b>Beschreibung der Betriebsstörung / Description of failure</b>   |  |   |
| <u>Datum der Störung / date of failure:</u><br><br><u>Kurzbeschreibung der Störung / brief failure description:</u>  |  |   |