



LESLIE
CONTROLS, INC.

A subsidiary of CIRCOR International, Inc.
12501 Telecom Drive • Tampa, FL 33637-0906

Installation, Operating and
Maintenance Instructions

26/2.6.1
Rev. 2

PMC-2

ELECTRO-PNEUMATIC CONTROLLER

INTRODUCTION

Leslie PMC-2 Electro-pneumatic controller can be used to control pressure, temperature, liquid level, and other process variables. It accepts signals from standard 4-20 mA transmitters and RTD's and provides a pneumatic output to operate the diaphragm or piston actuator of a control valve, thus providing single loop control. All PMC-2 units have two types of solenoids: A large solenoid for supplying large volumes of air quickly and two sets of small solenoids for supplying small volumes of air for positioning accuracy. If the unit is connected to an actuator with a small volume of required air the large solenoid can be dialed out by increasing the Quick Response Setting.

The PMC-2 has the following features:

1. Controller provides 24 volts DC power for transmitter, eliminating the need for a separate DC power supply.
2. Controller provides high volume air output at pressures up to 100 psig (6.9 bar) to directly operate the diaphragm or piston actuator of a control valve. I/P transducers and valve positioners are not required or recommended.
3. No small air orifices to plug or foul (0.06-inch diameter Solenoid ports).
4. No air consumption at steady state. Air is only used when needed to reposition valve actuator stem.

The PMC-2 unit contains two microcomputers, one dedicated to control and one dedicated to communications. Input settings are changed through the communications microcomputer, which downloads changed settings to the control microcomputer. This allows the user to change settings without interrupting process control. The PMC-2 unit will read and store data. Unit setup is done using the LCD display and membrane push button switches located on front of the PMC-2. LCD display also signals when unit is running properly, when unit has been taken off-line (no longer controlling process) and when unit has detected a fault that must be attended to.

Inspection

This equipment has been adequately packaged and protected for shipping; however, damage may have occurred in transit due to improper handling. When unit arrives at its final destination, it should be carefully inspected for damage and equipment malfunction. Serial number will be marked on unit.

Storage

Units should be stored in a clean, cool and dry location and should be protected from dirt, chips, dust, and insects or other nesting animals.

Replacement Parts

It is recommended that one set of Recommended Spare parts be inventoried for each unit. Recommended Spare Parts are identified on Assembly Drawing. Replacement parts can be ordered from your local Leslie representative. When ordering parts please include the serial number, type of service, Part Name, Balloon Number and Quantity as shown on Assembly Drawing.

Mounting Position

Normal controller installation is on valve or on wall near valve to be operated.

Controller can be mounted in any position to work around existing pipeline. Mount controller in a location that will allow access to front panel. See Appendix M for mounting dimensions. Unit should be mounted in a location where ambient temperature will be between -4 degrees F and 140 degrees F. Temperatures above or below these limits will affect the LCD display although the controller may continue to function. A location within 25 feet of the control valve actuator is recommended to reduce time lags in pneumatic signal.

Contact Information

For information concerning warranties, or for questions about installation, operation or maintenance contact:

LESLIE CONTROLS INC.
12501 Telecom Drive
Tampa, FL 33637
USA Phone: (813) 978-1000
USA Fax: (813) 978-0984
www.LESLIECONTROLS.com
USA/Canada/Caribbean Phone: (800) 323-8366

Leslie Service

Leslie service personnel are available to start up and repair our products. Leslie can also train your personnel to do this work. Contact Leslie representative nearest you for details.

Description of Operation

Electronic circuit of controller converts 4-20 mA signal from transmitter to a 1 to 5 volt input voltage. Input voltage is compared with 1 to 5-volt set point voltage and an error signal is created. Error signal is fed to a microcomputer, which is compared to deadband setting, accuracy setting, deadband delay, and quick response setting. Microcomputer computes best response for solenoid valves and actuates them accordingly. Microcomputer develops best strategy for moving actuator stem as fast as possible without overshoot. If error correction requires one solenoid to click on and off for two milliseconds then this is response. If it requires all of solenoids to turn on, then this is response. Microcomputer re-calculates and can change required response at a rate of 100 MHz.

Description of Parameters:

1. **Quick Response Setting**--% of full span error that large solenoid will be activated. For small actuators or temperature control this setting should be set at maximum. This activates only above the accuracy setting.
2. **Accuracy Setting**--% of full span error that small solenoids will no longer try to adjust actuator. Use this setting to reduce duty cycle of small solenoids and prevent hunting.
3. **Deadband Setting**--% of full span error (+/-) that unit will not respond to. Use this setting to stop unit from responding to noisy signals.
4. **Deadband Delay Setting**--Time in seconds for microcomputer to delay implementing Deadband Setting. Use this setting to allow unit to position actuator closer to accuracy setting but not continue to adjust or hunt due to a noisy signal or sticking valve.
5. A **Hard Start** is one in which controller will open or close valve as fast as possible to achieve Set Point Setting. Note: This may cause water hammer effects in some systems.
6. A **Soft Start** is one in which controller slowly increases set point over a chosen time period until chosen operational set point is reached. Used primarily on temperature applications

CAUTION!

Controller can automatically or manually open valve it is connected to in piping system. Ensure that changes in connected valve opening do not result in dangerous conditions.

WARNING

Electrical power must be supplied through an external circuit breaker or fuse protection. An external switch must be provided to turn off power. Always turn off power before removing internal field-wiring panel.

Pre-Installation Check

It is recommended that air-piping system be flushed prior to initial start-up. Debris in pipeline could damage unit or associated components. Before controller is installed, ensure that pipe fittings are free of foreign material that may have been introduced during handling. Clean connection piping of all debris such as loose weld spatter, scale, oil, grease or dirt. Clean air regulator if one is used. Make sure all valves are open during flushing operation. Connect air supply through a 50-micron filter regulator that has a pressure gauge to 1/8-inch NPT connection marked INPUT. If supply air is mixed with traces of oil, a filter capable of removing oil should be used. Some lubricating oils can permanently damage solenoid valves.

Air exhaust connection has already been supplied with a porous metal filter/silencer that should not be removed. Corrosion-resistant 3/8 inch OD tubing is recommended for air lines to and from unit. For single acting actuators, connect PMC-2 connection labeled "Output 1" to actuator and install a 1/8 inch NPT pipe plug into PMC-2 connection labeled "Output 2". For double acting actuators, connect PMC-2 connection labeled "Output 1" to top connection of actuator. Connect PMC-2 connection labeled "Output 2" to bottom connection of actuator. Test the actuator before connecting it to the unit to make sure it will cycle through its complete stroke.

Wiring

After mounting PMC-2 at desired location, open cover by loosening 2 screws and side latch. Remove field-wiring panel by loosening 3 captive screws. For any shielded lines, the shield should be grounded at either terminal 17 or 18 to ensure no RF interference. Terminals 25(+) and 25(-) are used if a remote set point is going to be used.

Transmitter

For a 4-20mA setup, refer to Figure 1 for a wiring diagram. The power output to the transmitter will connect to terminal 20 and the return will go to 21.

Figure 1: Transmitter wiring

Wiring Connections for 4—20 mA Transmitter (e.g. pressure or level)

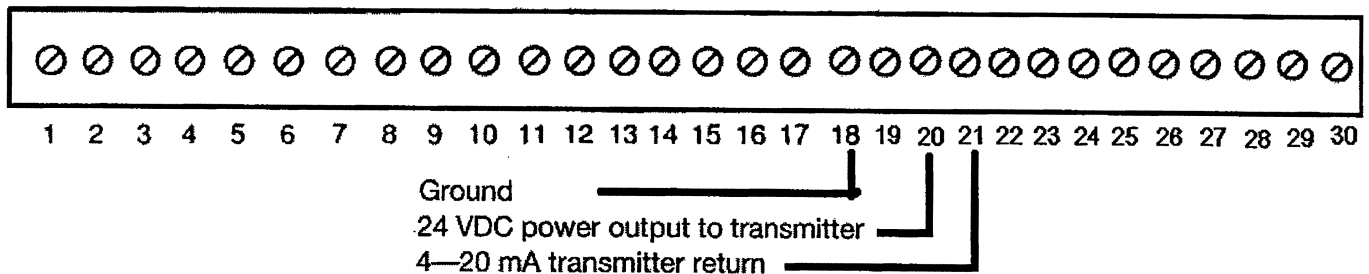

RTD

For a RTD setup, refer to Figure 2 for 2-wire and Figure 3 for 3-wire. No matter what type of RTD is used, terminals 18 and 19 MUST have a jumper between them. For a 4-wire RTD, please contact the manufacturer.

For a 3-wire RTD, the red terminal in the RTD is connected to terminal 22. The two black terminals are then connected to terminals 23 and 24.

For a 2-wire RTD, the black wire will go to 23, and then a jumper will have to be connected to 23 and 24. Because of this setup, there will be a slight error in the readings.

Figure 2: 2-wire RTD

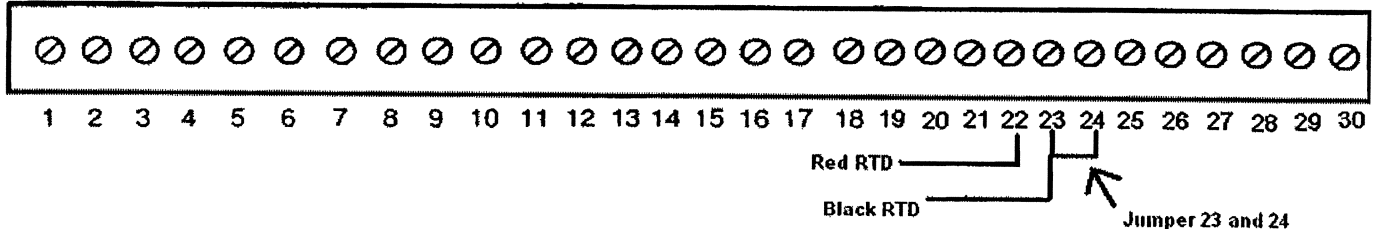
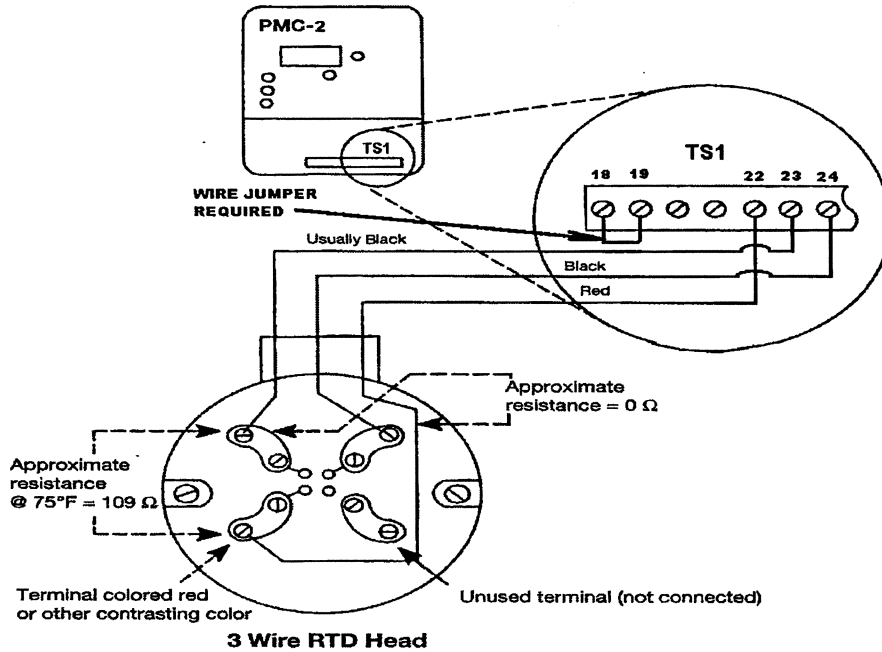

Figure 3: 3-wire RTD Wiring

CONNECTING AN RTD TO THE PMC-2



Initial Setup

1. Toggle Switch in PNEUMATICS section controls on/off operation of pneumatic valves. Placing switch in "up" position will cause valves to pump out air. Placing switch in "down" position disables air valves and no air is allowed in or out at any time. It is recommended that switch be placed in the down position during initial installation.

ATTENTION

1. Unit will display Fault light and stop controlling if either pressure or temperature sensors become disconnected or remote set point connection is lost. If all connections are good then Fault light in status section will be off.

WARNING

This instruction does not cover safety precautions and procedures required for safe start up of every system. Make sure you understand your system and its safe operation before start up.

Start-Up

USE THIS SECTION IF CONFIGURATION HAS NOT BEEN SET BEFORE OR CHANGES ARE REQUIRED. ALL VALUES FOR PARAMITERS ARE STARTING POINT REFERENCE VALUES ONLY. A TRANSMITTER or RTD NEEDS TO BE HOOKED UP AT ALL TIMES.

1. Turn on electrical power to PMC-2.
-
2. PMC displays:

PMC Okay & Off-Line
Navigate: > or >>

Status <input type="checkbox"/> Operating <input checked="" type="checkbox"/> Off Line <input type="checkbox"/> Fault	Pneumatics <input type="checkbox"/> Active <input checked="" type="checkbox"/> Disabled
---	--

3. "OFF-LINE" is lit.
-
4. LED for "Disabled" is lit in PNEUMATICS section switch is in down position.

Note: No action by user in 90 seconds will cause unit to return to starting point.

-
5. Push right side Main Menu button twice, LCD displays:

CONFIG: DISPLAY UNITS
none, psig, bar, degF

-
6. Press Up or Down button in Select section to choose measured units. Cursor will blink on units that are to be chosen. Note: Choosing "None" will eliminate display of units. Please mark units on tape and place on the display.

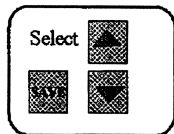

-
7. Press SAVE button to save your choice. Menu will cycle to:

-
8. Next menu item will be Air Action.
LCD displays:
CONFIG: AIR ACTION
Direct Reverse

-
9. Press Up or Down button in Select section to choose controller Output 1 port air action with increasing signal.

-
10. Press SAVE button to save your choice or keep choice shown and press right arrow Sub Menu button to scroll to next parameter.

-
11. Next menu item will be Set Point control.
LCD displays:
CONFIG: SET PT
LOCAL REMOTE

-
12. Press Up or Down button in Select section to choose how set point will be set. Local at the unit or remote from a control room.

-
13. Press SAVE button to save your choice or keep choice shown and press right arrow Sub Menu button to scroll to next parameter.

-
14. Next menu item will be Deadband.
LCD displays:
CONFIG: CONTROLLER
DEADBAND = XX%

NOTE: Deadband setting must be less than accuracy.

-
15. Press Up or Down button in Select section to choose Deadband required for your control situation.

-
16. Press SAVE button to save your choice or keep choice shown and press right arrow Sub Menu button to scroll to next parameter.

-
17. Next menu item will be Accuracy.
LCD displays:
CONFIG: CONTROLLER
ACCURACY = XX%

NOTE: Accuracy setting must be greater than deadband.

-
18. Press Up or Down button in Select section to choose Accuracy required for your control situation.

-
19. Press SAVE button to save your choice or keep choice shown and press right arrow Sub Menu button to scroll to the next parameter.

-
20. Next menu item will be Quick Response.
LCD displays:
CONFIG: CONTROLLER
QUICK RESPONSE = XX%

-
21. Press Up or Down button in Select section to choose Quick Response required for your control situation.

-
22. Press SAVE button to save your choice or keep choice shown and press right arrow Sub Menu button to scroll to next parameter.

-
23. The next menu item will be Deadband Delay.
LCD displays:
CONFIG: CONTROLLER
DEADBAND DELAY = XX%

-
24. Press Up or Down button in Select section to choose Deadband Delay required for your control situation.

-
25. Press SAVE button to save your choice or keep choice shown and press right arrow Sub Menu button to scroll to the next parameter.

-
26. The next menu item will be Fail Action.
LCD displays:
CONFIG: FAIL ACTION
LAST CLOSE OPEN

-
27. Press Up or Down button in Select section to choose Fail Action required for your control situation.

-
28. Press SAVE button to save your choice or keep choice shown and press right arrow Sub Menu button to scroll to the next parameter.
-

29. For transmitter the menu item will be Sensor Limit low.

LCD displays:

CONFIG: SENSOR LIMIT

4mA VALUE = 000 (unit of measure)

For RTD the menu item will be RTD deg Range.

LCD displays:

CONFIG: RTD deg RANGE

32/212 32/400 0/100

30. Press Up or Down button in Select section to choose lower limit of your transmitter scale.

31. Press SAVE button to save your choice or keep choice shown and press right arrow Sub Menu button to scroll to next parameter.

32. For transmitter the next menu item will be Sensor Limit high.

LCD displays:

CONFIG: SENSOR LIMIT

20mA VALUE = XXX (unit of measure)

Note: This will not show up for an RTD setup.

33. Press Up or Down button in Select section to choose upper limit of your transmitter scale.

34. Press SAVE button to save your choice or keep choice shown and press right arrow Sub Menu button to scroll to next parameter.

35. The next menu item will be Soft Start ramp time.

LCD displays:

CONFIG: SOFT START

RAMP TIME = XXX MIN

36. Press Up or Down button in Select section to choose ramp time of for start up of your system. If you are not using soft start then press right arrow Sub Menu button and skip this setting.

37. Press SAVE button to save your choice or keep choice shown and press right arrow Sub Menu button to scroll to next parameter.

38. Next menu item will be Soft Start ramp time.

LCD displays:

CONFIG: SOFT START

START PT = XXX (unit of measure)

39. Press Up or Down button in Select section to choose start point for ramping of your system. If you are not using soft start then press Sub Menu button and skip this setting.

40. Press SAVE button to save your choice or keep choice shown and press right arrow Sub Menu button to scroll to the next parameter.

41. Next menu item will be Set Point Value for local control. If you are not using Local set point control then this menu will be skipped.

LCD displays:

SET POINT: LOCAL

SET/SAVE = XXX (unit of measure)

42. Press Up or Down button in Select section to choose set point for your system.

43. Press SAVE button to save your choice or keep choice shown and press right arrow Main Menu button to scroll to the next parameter.

44. Next menu item will be Manual for local control of opening position of valve. Many people want to first manually open their valve a little before setting automatic controls in operation. Check that air is supplied to the unit to use this option. Even in manual mode all connections from the installation and setup need to stay connected including: air lines, transmitter, and input power.

CAUTION

Check to insure that applying air to actuator will not cause harm to people or systems.

45. Toggle switch in pneumatics section to Active.

46. Place Pressing the up or down buttons will cycle small solenoids to pump air into actuator slowly. Pressing SAVE button will change to large solenoid for changing air sent to actuator. If you do not want to use this then press Sub Menu button.

LCD displays:

OPERATE; MANUALY: use

UP/DOWN; FAST = SAVE

47. Press Up or Down button in Select section to choose actuator opening for your system.

48. Press SAVE button to change rate that air is supplied to actuator.

49. Next menu item will be Manual for local control of opening position of valve. Pressing the up or down

buttons will cycle the large solenoid to pump air into actuator quickly.

LCD displays:

OPERATE; MANUALLY: use
SET PT = XXX (unit of measure)

50. Press Up or down button in Select section to choose opening point for your system.

51. Press left arrow Sub Menu button in Select section to toggle back to small solenoids.

52. Press Main menu right arrow when finished.

53. Next menu item will be Start up. If you are ready to start automatic controls then not using Local set point control then this menu will be skipped.

LCD displays:

CONFIG: START UP
HARD SOFT-START

54. Press Up or Down button in Select section to choose start up situation for your system.

55. If HARD start is pressed then LCD displays:

HARD START
PRESS SAVE TO START

56. Pressing SAVE operates unit, Operating LED in STATUS block is lit and LCD displays:

OPRGT:S.P.: XXX UNITS
PMC ok Msr: XXX UNITS

57. If SOFT-START is pressed, LCD displays:

SOFT-START
PRESS SAVE TO START

58. Pressing SAVE begins SOFT-START mode: Operating LED in STATUS block is lit, LCD switches between displays as set-point is ramped up.

59. When set-point is reached, LCD displays:

OPRGT:S.P.: XXXXX UNITS
SOFT Msr: XXXXX UNITS

NOTICE

To stop controller at any time press Main menu right or left arrow once and then press SAVE button.

Run Time

PMC-2 will adjust opening and closing of valve to change in measured parameter (pressure, temperature, or level) that is being sent to it by a transducer or RTD. If during operation system parameters need to be changed for any reason, operator can use menu system to select desired parameter and then change it. Microcomputer will read and store new parameter during its next clock cycle. Thus, parameter changes are implemented immediately without stopping process control. This allows fine-tuning of control and changing of control when controlled system changes.

Example: A system to control pressure began that had very slow changes in down stream pressure. Quick Response on setting on PMC-2 was set to 18% (Quick Response was not needed unless there was a sudden change and error became 18% or more). Over time system has changed and now there are very fast pressure changes. PMC-2 Quick Response setting can now be changed to 4% while PMC-2 is controlling pressure. Procedure is:

1. Press right arrow Main menu button three times.
2. Press right arrow sub menu button to scroll to next menu item; Quick Response.

LCD displays:

CONFIG: CONTROLER
QUICK RESPONSE = XX%

3. Press Up button in Select section to choose maximum Quick Response. Press SAVE button to save your choice or keep choice shown and press right arrow Sub Menu button to scroll to next parameter if needed.
4. Once the save button is pushed the system will automatically use what you put in and go to run menu.

PMC-2 will now cause the control valve actuator to respond much more quickly to rapidly changing controlled pressure.

Ideal tuning of PMC-2 is with a minimum setting of Quick Response setting, Accuracy setting, and Deadband setting that can be used without system going into constant oscillation after an upset

Change SET POINT while running

1. Press right Main menu arrow four times.
2. Next menu item will be Set Point Value for local control.
3. LCD displays:

CONFIG: SET POINT
SET PT = XXX (unit of measure)

4. Press Up or Down button in Select section to choose new set point for your system.
5. Press SAVE button to save your choice.
6. System will automatically use saved set point and return to the run menu.

Change any parameter while running

1. Press right Main menu arrow three times.
2. Next menu item will be Display units.
LCD displays:
CONFIG: DISPLAY UNITS
none, psig, bar, degF
Or for RTD:
CONFIG: DISPLAY UNITS
degF
3. Press right arrow Sub Menu button to scroll to t parameter needed to be changed.
4. Press SAVE button to save your choice.
5. System will automatically use saved set point and return to the run menu.

Table 1: Trouble Shooting

If....	Then....
Controller does not operate at all and no lights are shown.	Check power connections.
Final control valve operates in opposite direction.	Check that controller is in expected mode (Direct or Reverse) Check that pneumatic piping is connected to proper connection at actuator and at controller (Output 1 to bottom and Output 2 to top of actuator).
Valve repeats up and down motion quickly or in large changes.	Increase Quick Response setting to maximum and then reduce setting in small steps until cycling resumes. Change Quick Response setting back to setting before cycling began.
Valve cycles up and down in small changes	Increase Deadband setting to maximum and then reduce setting in small steps until cycles return. Change Deadband setting back to setting before cycling began.
Controller will not clear "Fault" light.	Check and make sure connections to RTD or pressure sensor are secure. Check RTD or pressure sensor wires for continuity.
If all status lights are on and LCD is lit but no control.	+24 V DC power or current supplied to unit is too low to operate the unit. Check power supplied to the unit.
Loss of remote set point	Fault light come on, Set point is 0, unit fails to "Fail Action" setting
Fault light is off when unit is "Off Line", Fault light is on when unit is "ON Line"	4-20 transmitter wires are connected backwards. Positive is connected to negative and negative to positive. Reverse wire connections.

Table 2: TERMINAL BOARD LABELS

Terminal #	Label	Use
1	CHAS	Chassis Ground
2	GND	Power input Ground
3	CAN	AC Voltage Neutral Power Input
4	ACH	AC Voltage Hot Power Input
5	+24 V	Plus 24 Volts DC Power Input
6	COM	Common Ground
7	HiLim	Normally Open Limit Switch, Normally Closed when measured value reaches maximum
8	HiLim	Normally Open Limit Switch, Normally Closed when measured value reaches maximum
9	LoLim	Normally Open Limit Switch, Normally Closed when measured value reaches minimum
10	LoLim	Normally Open Limit Switch, Normally Closed when measured value reaches minimum
11	OpSlo	Used for System Diagnostics
12	ShSlo	Used for System Diagnostics
13	OpFst	Used for System Diagnostics
14	ShFst	Used for System Diagnostics
15	U24	+24 Volt Supply Voltage
16	COM	Common Ground
17	COM	Common Ground
18	COM	Common Ground
19	eRTD	Jump to Terminal 18 if RTD is used for temperature measurement
20	+EXC	+24 Volts DC for powering 4-20 mA Devices (can plug in self powered device here as well)
21	I _{sen}	4-20 mA Device return line for measurements
22	RTD+	+ RTD Connection, Red wire
23	RTD-	- RTD Connection, Black wire
24	RTD-	- RTD Connection, Black wire
25	I _{sp} +	+ 4-20 mA Connection for Remote Setpoint Control
26	I _{sp} -	- 4-20 mA Connection for Remote Setpoint Control
27	I _m +	+ DC Connection for Remote Sensing of the Measured Controlled Pressure or Temperature in terms of a 4-20 mA reading.
28	I _m -	- DC Connection for Remote Sensing of the Measured Controlled Pressure or Temperature in terms of a 4-20 mA reading
29	BusA	Mod Buss Connection
30	BusB	Mod Buss Connection

Table3: SPECIFICATIONS

SUPPLY VOLTAGE:	115 VOLTS 50/60 HZ 24V DC
OPERATING VOLTAGE RANGE:	90 TO 110% OF RATED VOLTAGE
POWER CONSUMPTION:	10 WATTS (MAX.), 0.7W STEADY STATE
INPUT RESISTANCE TO CURRENT LOOP	250 Ohms
INPUT SIGNAL:	4 - 20 ma(STD), PROTECTED AGAINST ACCIDENTAL OVERVOLTAGE. INPUT TERMINALS FOR RTD VOLTAGES , RANGES 32° to 221° F AND 32° F TO 400° F
OUTPUT:	4 - 20 Ma(STD), ACCURACY = +/- 5% SETTING LOAD = 350 OHMS MAX.
OUTPUT MODES	AUTO AND MANUAL
REMOTE SET POINT ADJUSTMENT:	ANALOG INPUT OR MODBUS RTU
AIR OUTPUT:	0 TO MAXIMUM SUPPLY PRESSURE
AIR DELIVERY:	1.7 SCFM (0.05 CMM) AT 90 PSIG (6.2 BAR) MIN 10.6 SCFM (.3 CMM) AT 90 PSIG (6.2 BAR) MAX
AIR CONSUMPTION:	NO AIR CONSUMPTION AT STEADY STATE
PNEUMATIC FITTINGS	1/8 NPT (FEMALE)
DEADBAND SETTING	0 TO 15% OF FULL SPAN
ACCURACY SETTING	0 TO 10% OF FULL SPAN
DEADBAND DELAY SETTING	0 TO 3 SEC
QUICK RESPONSE SETTING	0 TO 20% OF FULL SPAN
AMBIENT TEMPERATURE	-4 to 140 DEGREES F(-20 to 60 DEGREES C)
ENCLOSURE MATERIALS	ENCLOSURE: NORYL HINGED COVER: POLYCARBONATE
ENCLOSURE APPROVAL	NEMA 1-2-3-3S-4-4X-12-13
WEIGHT	8 LBS (3.6KG)

Figure 3: PMC-2 CONTROLLER MOUNTING DIMENSIONS

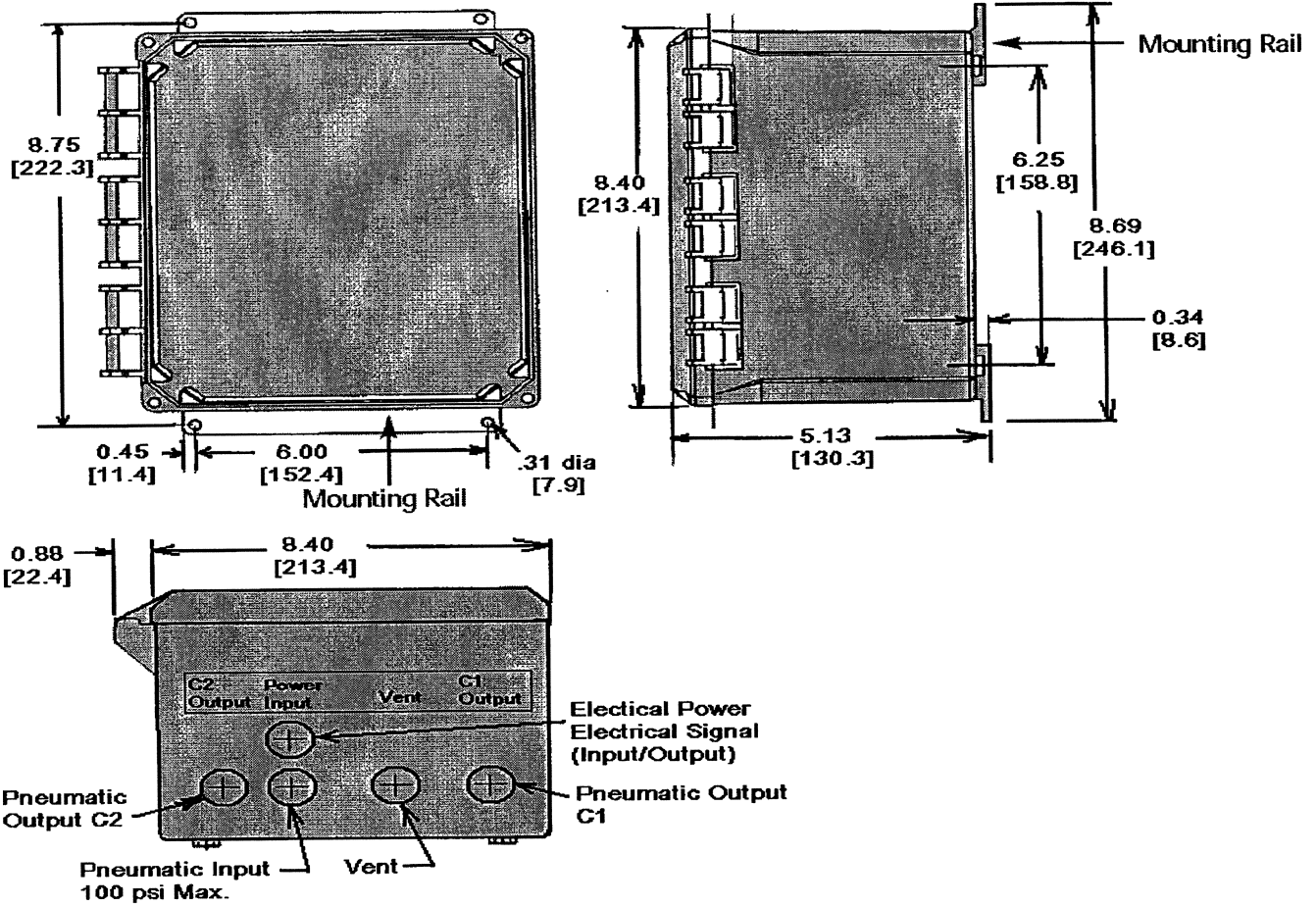
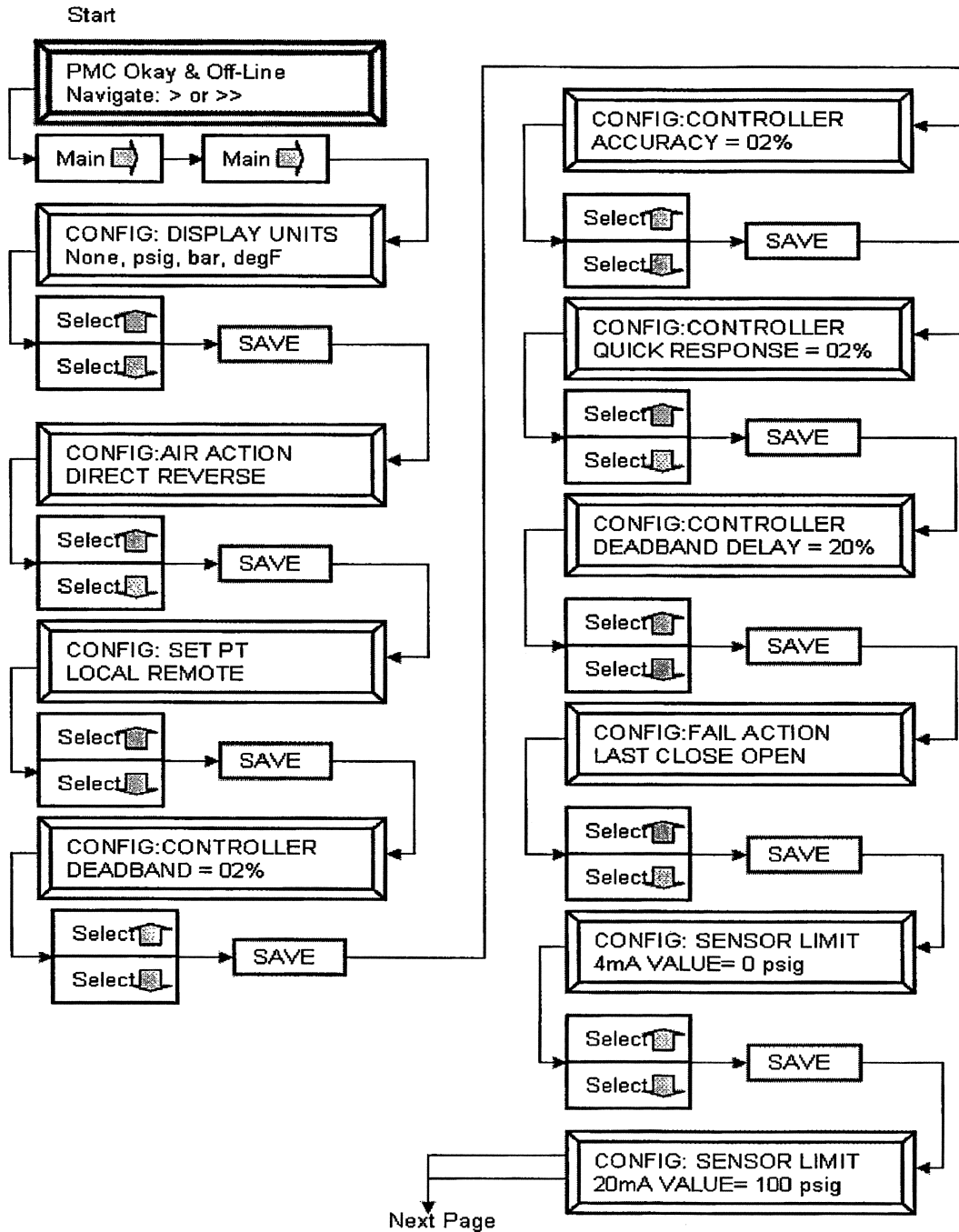
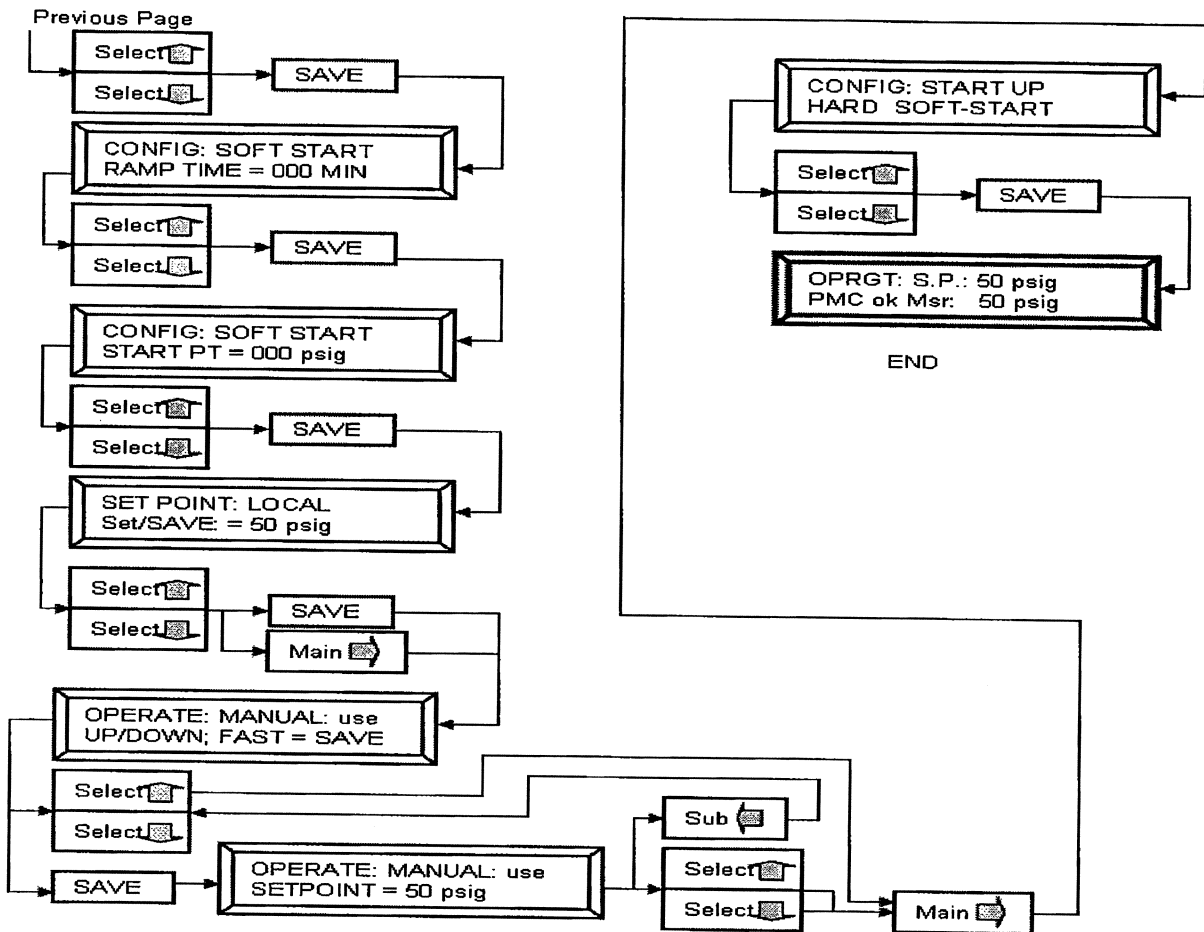

Figure 4: Menu Flowchart





A subsidiary of CIRCOR International, Inc.
12501 Telecom Drive • Tampa, FL 33637-0906

It is solely the responsibility of the system designer and the user to select products and materials suitable for their specific application requirements and to ensure proper installation, operation and maintenance of these products. Assistance shall be afforded with the selection of the materials based on the technical information supplied to Leslie Controls Inc.; however, the system designer and user retain final responsibility. The designer should consider applicable Codes, material compatibility, product ratings and application details in the selection and application. Improper selection, application or use of the products described herein can cause personal injury or property damage. If the designer or user intends to use the product for an application or use other than originally specified, he must reconfirm that the selection is suitable for the new operating conditions.