



PRODUCT SERVICE MANUAL SERIES 110H & 210H



WARNING

The IMO General Installation Operation, Maintenance and Troubleshooting Manual, (No. SRM00046), this manual, and associated component manuals supplied with the unit should be read thoroughly prior to pump installation, start-up, operation, maintenance or troubleshooting.

Manual No. SRM00011

Rev. 06 (20-0051)

Date: February 2020



READ THIS ENTIRE PAGE BEFORE PROCEEDING

FOR THE SAFETY OF PERSONNEL AND TO PREVENT DAMAGE TO THE EQUIPMENT, THE FOLLOWING NOMENCLATURE HAS BEEN USED IN THIS MANUAL:

	DANGER
Failure to observe the precautions noted in this box can result in severe bodily injury or loss of life.	

	WARNING
Failure to observe the precautions noted in this box can cause injury to personnel by accidental contact with the equipment or liquids. Protection should be provided by the user to prevent accidental contact.	

CAUTION	ATTENTION
Failure to observe the precautions noted in this box can cause damage or failure of the equipment.	

Non-compliance of safety instructions identified by the following symbol could affect safety for persons: <div style="text-align: center;"></div>	Safety instructions where electrical safety is involved are identified by: <div style="text-align: center;"></div>	Safety instructions which shall be considered for reasons of safe operation of the pump and/or protection of the pump itself are marked by: <div style="text-align: right; margin-top: 10px;">ATTENTION</div>
---	--	---

ATTENTION
If operation of this pump is critical to your business, we strongly recommend you keep a spare pump or major repair kit in stock at all times. As a minimum, a minor repair kit (O-rings, gaskets, shaft seal and bearings) should be kept in stock so pump refurbishment after internal inspection can be accomplished.

CONTENTS

Safety and Table of Contents	Inside Cover
General Instructions	1
Ordering Instructions.....	1
Introduction	1
Special Installation Instructions.....	2
Description of the Equipment	2
Assembly and Disassembly Instructions	3
Parts List and Pump Assembly Drawing	4
Disassembly of Mechanical Shaft Seal	5
Installation of Mechanical Shaft Seal	6

GENERAL INSTRUCTIONS

The instructions found herein cover the disassembly, assembly and parts identification of Series 110H and 210H pumps.

NOTE: Individual contracts may have specific provision that vary from this manual. Should any questions arise which may not be answered by these instructions, refer to the General Instructions Manual, CA-1, provided with your order. For further detailed information and technical assistance please refer to Imo Pump, Technical Service Department at (704) 289-6511.

This manual cannot possibly cover every situation connected with the installation, operation, inspection and maintenance of the equipment supplied. Every effort was made to prepare the text of the manual so that engineering and design data is transformed into the most easily understood wording. Imo Pump must assume the personnel assigned to operate and maintain the supplied equipment and apply this instruction manual have sufficient technical knowledge and are experienced to apply sound safety and operational practices which may not be otherwise covered by this manual.

ORDERING INSTRUCTIONS

All correspondence pertaining to renewal parts for the equipment must refer to the instruction manual number and should be addressed to the nearest Imo representative. The handling of renewal orders will be greatly facilitated if the following directions are carefully observed:

1. Give the number of the instruction manual.
2. Give the model number of the pump for which the part is desired. This number appears on the nameplate.
3. Designate the desired part by the IDP number and name as listed in Table 1 and pump assembly drawing in this instruction manual.

INTRODUCTION

This manual covers all basic models of the 110H and 210H series Imo pumps. The model of a particular pump may be found on the nameplate. Definitions of model designators are given in Figure 1.

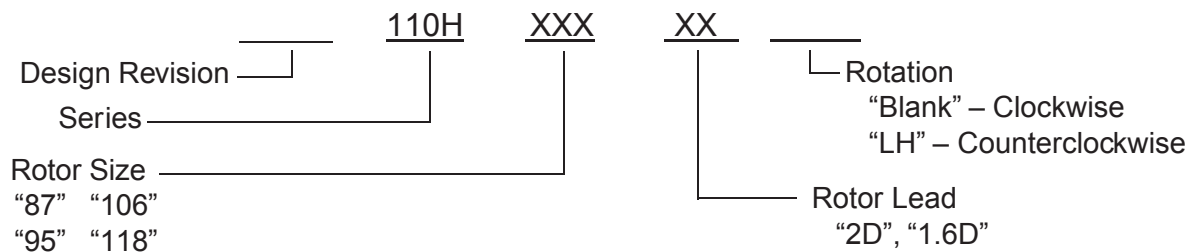

Figure 1 – Definition of Model Designators

SPECIAL INSTALLATION INSTRUCTIONS

1. **Driver** – The Series 110H and 210H may be mounted in any position without affecting the operation of the pump. Of all the positions, the least desirable position for applications involving cyclic duty, is with the pump mounted with the shaft down in a vertical position, that is with the pump above the motor. It is recommended that the unit be driven directly through a flexible coupling.
2. **Inlet Position** – The inlet flange may be positioned in increments of 90° from the position shown on the assembly drawing. To change the position of the inlet flange, remove the socket head cap screws (6) and lock washers (7). Rotate the housing (1) and the inlet head (2) as a unit taking care not to damage o-ring (9). Install the socket head cap screws with their lock washers and torque per pump assembly drawing, page 5.
3. **Suction Strainer** – A suction strainer of at least 100 mesh with a flow capacity of 30-50 gpm and a pressure drop not exceeding 0.5 psi (when newly installed) should be used. (The inlet strainer shall be sized to insure that the pressure at the inlet port of the pump will not, under any circumstances, exceed 10 inches of mercury vacuum). Maintenance instructions shall provide for the periodic cleaning or replacement of the inlet strainer.

DESCRIPTION OF EQUIPMENT

CAUTION

Operating conditions, such as speed, fluid viscosity, temperature inlet pressure, discharge pressure, filtration, duty cycle, drive type, mounting, etc. are interrelated. Due to these variable conditions, the specific application limits may be different from that of the operational limitations. This equipment must not be operated without verification that operating requirements are within its capabilities.

OPERATING TEMPERATURE AND THERMAL SHOCK EXPOSURE

Never operate with water. The pump is designed for liquids having the general characteristics of oil.

Under NO circumstances are the following operating limitations to be exceeded:

Operating Pressure: 1200 PSIG max. continuous for model 110H with lube and hydraulic oils.
1500 PSIG max. continuous for model 210H with lube and hydraulic oils.
Up to 2000 PSIG under approved conditions. Consult Imo.

Inlet Pressure: 35 PSIG maximum

Temperature: 180°F, assuming fluid viscosity is within allowed limits.

CAUTION

Never exceed the equipment's minimum or maximum allowable fluid temperature. Do not expose equipment to thermal shock. Differences in metallurgy and their respective coefficients of expansion could cause distortion of pump parts resulting in a breakdown condition.

ASSEMBLY AND DISASSEMBLY PROCEDURES

Note: Refer to part numbers as shown on the pump assembly drawing and the IDP numbers in Table 1.

WARNING

Before starting any maintenance procedure:

- Remove electrical service fuse, de-energize and lock the electrical service panel supply to the driver.
- Shut, wire or chain shut and lock all pump piping valves. If applicable, shut off any steam supply lines to the pump and/or driver.

If seal only is to be serviced, follow the disassembly and reassembly procedures on pages 4 and 5.

If complete overhaul of pump is required, removal of pump from its mounting and locating the pump in a suitable work area is recommended. It is also recommended that all gaskets and the seal be replaced during overhaul; regardless of their condition.

PUMP DISASSEMBLY

1. Remove pump from the bracket.
2. Remove the four cap screws (6) and lock washers (7) and remove the inlet head (2).
3. Remove the idler rotors (14) with their thrust shoes (15) by screwing them out of the rotor housing (1).
4. Remove rotor housing (1) with o-rings (9). Do not remove pin (21).
5. Remove four cap screws (23) and ball bearing retainer (22).
6. Remove power rotor assembly from outlet head (4).

Note: Special detailed disassembly procedure for the removal of the ball bearing and seal are provided on page 4.

PUMP ASSEMBLY

Note: Clean and inspect all parts before assembly. Replace all worn or damaged parts. It is recommended that gaskets and mechanical seal be replaced regardless of their condition. Wipe each part with light lubricating oil just before installing. Rotate power rotor (34) frequently during assembly to ensure freedom of rotation.

1. Clean all parts prior to assembly.
2. Install power rotor assembly in outlet head (4).

Note: Special detailed instructions for power rotor assembly are given on page 5.

3. Install ball bearing retainer (22) and four cap screws (23). Torque cap screws uniformly per drawing on page 4.

4. Lubricate the housing pilots with a light oil or hydraulic fluid and install new O-rings (9) against shoulder of housing (1).
5. Lubricate the thread section of the power rotor (11) and install housing on outlet head (4).
6. Lubricate idler rotors (13) with light oil or hydraulic fluid and screw into housing.
7. Install inlet head (2) with capscrews (6) and lock washers (7) per drawing on page 3. Turn power rotor by hand. Rotor should turn freely.
8. Install key (19) in rotor keyway. Make sure that the key does not overhang the end of the shaft.
9. Align pump to bracket and install pump mounting bolts.

IDP	Description	IDP	Description
1	Rotor Housing	10*	Power Rotor Sub-Assembly*
2	Inlet Head	13	Idler Rotor Sub-Assembly** (2)
4	Outlet Head	23	Retainer
5	Balance Piston Bushing	16 X	Ball Bearing
6	Cap Screw (4)	17 X	Snap Ring (2)
7	Lock Washer (4)	19	Coupling Key
8	Plug	20 X	Seal
9 X	O-Ring (2)	21	Pin

*Piece (10) consists of parts (11) and (12). These parts are factory mounted and not serviced separately.

Recommended Spare Parts:

All parts marked X make up a minor repair kit. Other parts cannot be serviced.
 All quantities are one except when noted in Parentheses.

Table 1 – List of Material

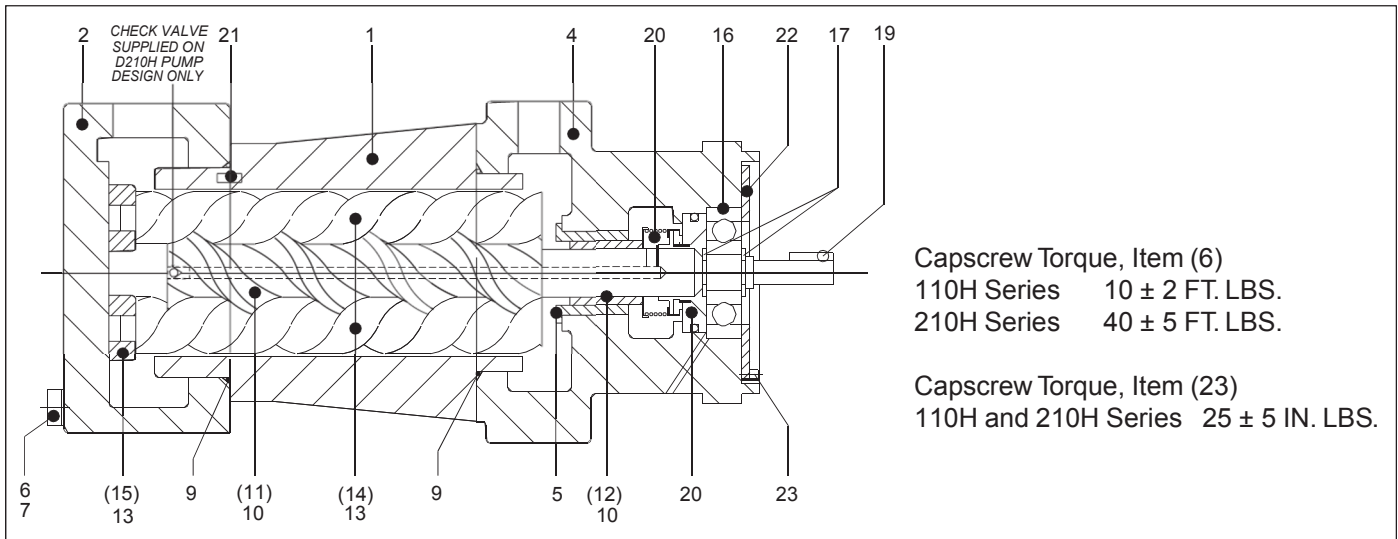

Pump Assembly Drawing

DISASSEMBLY OF MECHANICAL SHAFT SEAL

1. Remove four cap screws (23) and ball bearing retainer (22). Pull power rotor from outlet cover of pump.
2. After removing coupling hub from rotor, remove outer snap ring (17) from power rotor as shown in Figure 1.
3. Insert rotor assembly in press as shown in Figure 2, and gently press to move bearing approximately one-eighth (1/8") inch. Do not try to press bearing completely off because another snap ring (17) between seal seat and bearing limits seal seat movement.
4. Separate bearing and seal seat as shown in Figure 3. Insert two pieces of key stock between ball bearing and seal seat. Continue to press bearing from shaft. Discard bearing.
5. Remove snap ring (17) using standard external snap ring pliers (Figure 4). Hold seal seat during this operation to prevent spring force from pushing seal assembly apart.

Note: Seal bellows will normally be bonded to shaft.

6. Remove seal seat. Remove seal subassembly as shown in Figure 5 and inspect the shaft. If shaft is pitted or badly scratched or snap ring grooves are damaged, the rotor subassembly (10) must be replaced.
7. Clean shaft and snap ring grooves prior to installing new seal and bearing. Do not use old seal or bearing.



FIGURE 1



FIGURE
2

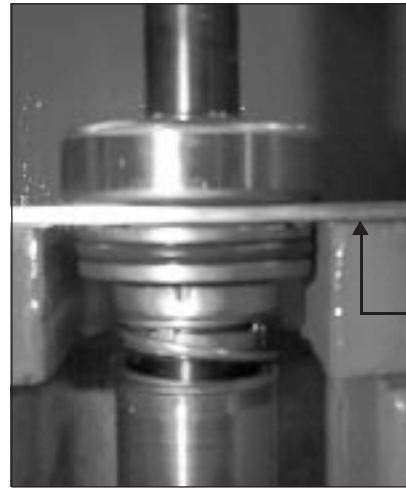

FIGURE 3



FIGURE 4



FIGURE 5

INSTALLATION OF MECHANICAL SHAFT SEAL TYPE 110H & 210H HYDRAULIC PUMP

1. To install the mechanical shaft seal, clean the shaft with solvent to remove dirt and grease. Lubricate shaft with clean light lubrication oil (DO NOT USE GREASE).
2. After placing spring holder and spring on shaft, grasp seal subassembly as shown in Figure 1, and using a rotating motion, gently slide the seal subassembly on the shaft. Use care not to cut the flexible Bellows. See seal subassembly Figure 6 showing seal seat retainer, carbon ring flexible diaphragm and drive ring. Clean seal faces with alcohol and apply a light coat of clean oil.
3. Slide seal seat over shaft and compress seal assembly against power rotor balance piston to expose snap ring groove.
4. Using standard external snap ring pliers, install snap ring (17) as shown in Figure 2. Properly seated snap ring is as shown in Figure 3.
5. Place ball bearing (16) on shaft. Then using a hollow tube and pressing on the inner race, seat the bearing firmly against the snap ring as shown in Figure 4.
6. Check mechanical seal – referring to Figure 6, the flexible Bellows must show evenly out of the drive ring. The drive lugs on the retainer must engage the drive ring to their full strength. Make sure seal bellows is not covering the drilled seal return hole in the power rotor.
7. Install outer snap ring (17), Figure 5.
8. Lightly oil rotor threads and install rotor assembly into outlet cover.



FIGURE 1



FIGURE 2



FIGURE 3

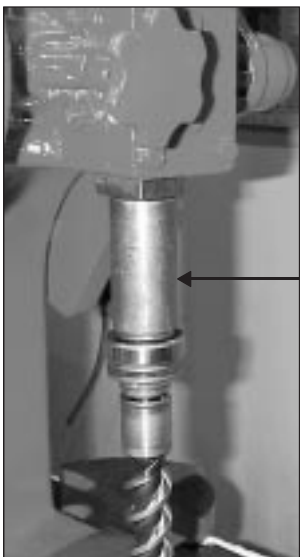

FIGURE 4

BEARING
TOOL



FIGURE 5

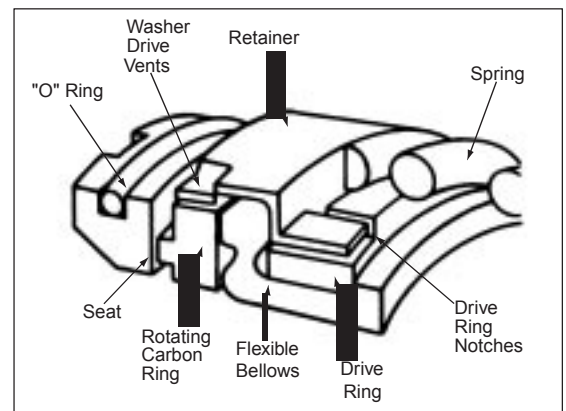

FIGURE 6

CIRCOR
1710 Airport Road -28110
PO Box 5020
Monroe, NC/USA 28111-5020
Tel: 1.877.853.7867
Fax: 1+(704) 289-9273

Email: cc@circor.com
Web: www.circorpt.com

